

COLLECTION
SIGNATURE EIGHT

VISMARA
BEAUTY & SPA DESIGN

MADE IN ITALY
2025

Armonia, concretezza, passione.
Realizziamo da oltre 20 anni elementi
di arredo che ascoltano i desideri delle
persone, ricerchiamo la bellezza e la
funzionalità in ogni creazione perchè
possano durare nel tempo.

Harmony, concreteness, passion.

*For over 20 years we have been producing products paying attention to
people's desires. We look for beauty and functionality in all our creations
so that they can survive of over time.*

Per noi, il lavoro è un percorso,
un sentimento... il laboratorio è
l'ambiente dei valori condivisi: design,
cura, ricerca del dettaglio, eccellenza
nell'esecuzione, scelta accurata delle
essenze. In una parola: qualità.
Questa è la vera espressione del
made in Italy

For us the work is a path, is a feeling...

*The workshop is a place of shared values: design, attention, study of
details, excellence in execution, careful choice of the essences. In one
word: quality. This is the real expression of Made in Italy*

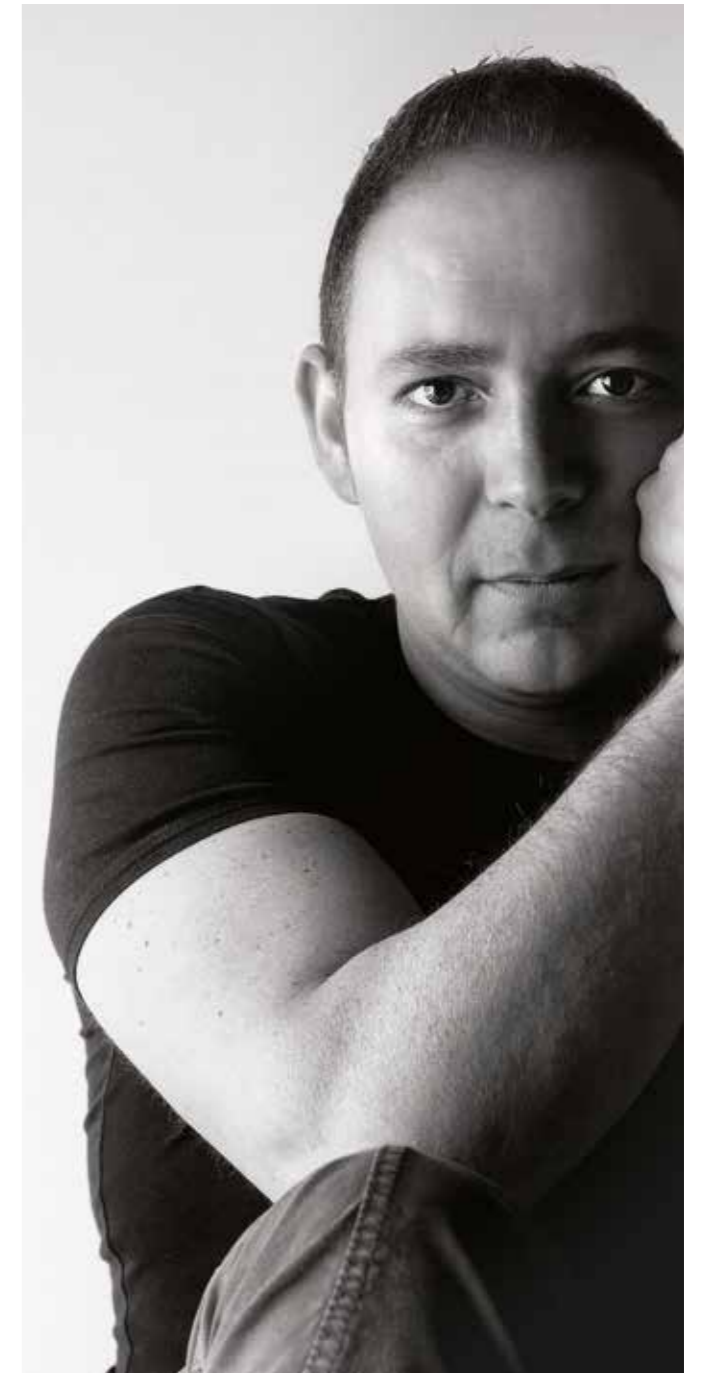

Cristian Vismara
founder & designer

Progettazione e realizzazione di lettini e mobili per centri benessere e SPA: l'eccellenza di Vismara Benessere.

Design and creation of massage bed and furniture for wellness centres and spas: the excellence of Vismara Benessere.

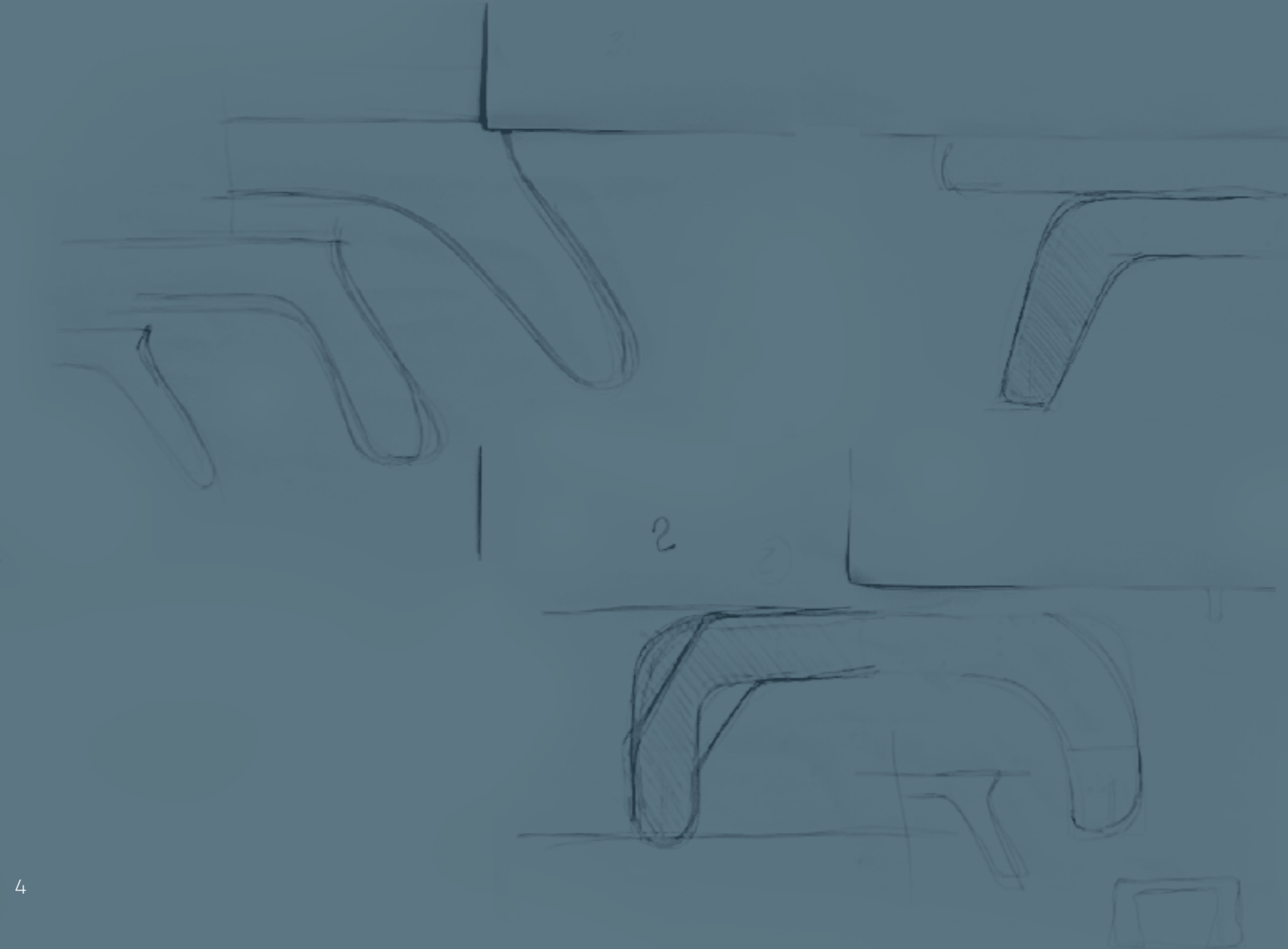

I prodotti Vismara Benessere nascono da un'attenta progettazione, punto focale del processo produttivo. Questo approccio consente di dar vita a mobili non solo eleganti ma anche ergonomici e funzionali.

Lo stile raffinato e la cura dei dettagli garantiscono un perfetto equilibrio tra estetica e benessere, offrendo un'esperienza di relax completa.

Dal progetto alla realizzazione, l'azienda propone soluzioni personalizzate e innovative capaci di soddisfare appieno le esigenze specifiche di ogni cliente. Finiture che spaziano dal bianco puro ai toni caldi, fino a colori decisi e profondi che esprimono carattere e stile, mentre le essenze selezionate evocano sensazioni autentiche e vibranti.

Vismara Benessere products are the result of careful design, focal point of the production process. This approach allows to create furniture that is not only elegant but also ergonomic and functional. Refined style and attention to the details guarantee a perfect balance between aesthetics and well-being, offering an experience of complete relaxation. From design to realization, the company offers customized and innovative solutions able to fully satisfy the specific needs of each customer. Finishes ranging from pure white to warm tones, up to bold and deep colours that express character and style, selected essences evoke authentic and vibrant sensations.

Una gamma completa di prodotti pensati per soddisfare le esigenze dei professionisti del settore. Le sue quattro linee principali combinano funzionalità, design e qualità, garantendo soluzioni personalizzate e di alto livello.

A complete range of products designed to meet the needs of professionals in the sector. Four main ranges combine functionality, design and quality, guaranteeing customized and high-level solutions.

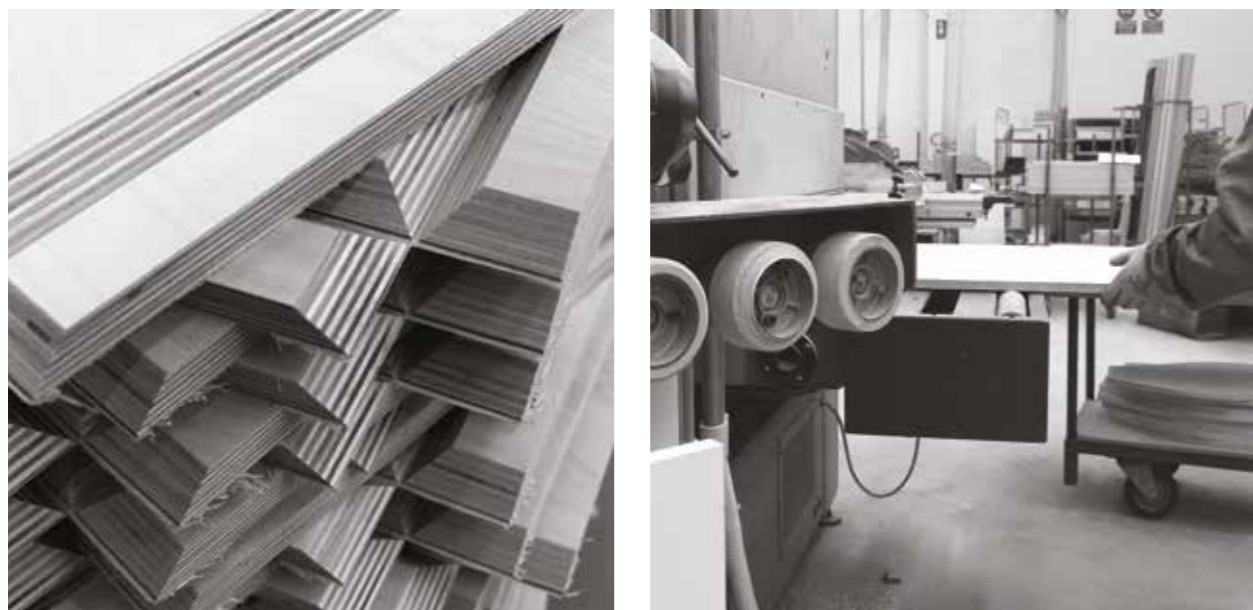

LETTINI, ISOLE, MOBILI & ARREDI e COMPLEMENTI & ACCESSORI

Lettoni da massaggio

I lettini da massaggio di Vismara Benessere rappresentano l'eccellenza in termini di ergonomia e comfort. Progettati per offrire il massimo relax al cliente e facilitare il lavoro degli operatori, i lettini si distinguono per la cura nei dettagli e l'alta qualità dei materiali.

Isole

Pensate per offrire il massimo comfort sia ai clienti che agli operatori, le isole per nail care e le poltrone podologiche sono il risultato di una progettazione attenta e studiata nei minimi particolari. Le soluzioni ergonomiche e regolabili permettono di realizzare trattamenti in totale comodità, valorizzando l'esperienza dell'utente. Ogni elemento è creato con l'obiettivo di unire funzionalità e stile, adattandosi perfettamente a qualsiasi ambiente professionale.

Mobili e arredi

La linea di mobili e arredi si contraddistingue per l'eleganza e la versatilità. Offriamo soluzioni progettate per ottimizzare gli spazi e creare ambienti di benessere armoniosi e accoglienti. Ogni elemento è studiato per coniugare estetica e praticità, fornendo arredi che esaltano l'atmosfera rilassante delle SPA e dei centri wellness.

Complementi e accessori

Per completare e arricchire gli spazi dedicati al benessere, Vismara Benessere propone una linea di complementi e accessori che spaziano da elementi decorativi a oggetti funzionali, sempre all'insegna dell'eleganza e del design. Ogni accessorio è pensato per armonizzarsi perfettamente con il resto degli arredi, aggiungendo un tocco distintivo e raffinato. Questi dettagli sono fondamentali per creare un ambiente benessere davvero unico e accogliente.

MASSAGE BEDS, ISLANDS, FURNITURE, COMPLEMENTS & ACCESSORIES

Massage beds

Vismara massage beds represent excellence in terms of ergonomics and comfort. Designed to offer maximum relaxation to the customer and facilitate the work of the operators, the massage beds stand out for their attention to detail and high quality of materials.

Islands

Designed to offer maximum comfort to both customers and operators, nail tables and podology chairs are the result of a careful design studied down to the smallest details. Ergonomic and adjustable solutions allow to carry out treatments in total comfort, enhancing user experience. Each element is created with the purpose to combine functionality and style, adapting perfectly to any professional space.

Furniture

Furniture stands out for its elegance and versatility. We offer solutions designed to optimize spaces and create harmonious and welcoming wellness spaces. Each element is designed to combine aesthetics and practicality, providing furnishings that enhance the relaxing atmosphere of the SPAs and wellness centres.

Complements and accessories

To complete and enrich the spaces dedicated to wellness, Vismara Benessere offers a line of complements and accessories ranging from decorative elements to functional objects, always in the name of elegance and design. Each accessory is designed to harmonize perfectly with the rest of the furnishings, adding a distinctive and refined touch. These details are essential to create a truly unique and welcoming wellness space.

LETTINI

MASSAGE BEDS



ARCUS
p. 14 | 19



LUI
p. 20 | 25



LUI MOVER
p. 20 | 25



LEI
p. 26 | 31



ANDROMEDA HYDRO
p. 102 | 105



NAT EVO PLUS
p. 32 | 37



NAT EVO
p. 38 | 43



NAT EVO MOVER
p. 38 | 43



VISION
p. 44 | 49



SENSE
p. 50 | 55



SENSE MOVER
p. 50 | 55



THE CLAIR
p. 56 | 61



THE BEN
p. 62 | 67



THE BEN MOVER
p. 62 | 67



E-MOTION 2.0
p. 68 | 71



VIS
p. 72 | 77



MADE
p. 78 | 83



FLOW
p. 84 | 89



LIVING
p. 90 | 93



CREO
p. 94 | 97



SWING
p. 98 | 101

ISOLE

BEAUTY CORNERS



TAHITI
p. 108 | 111



EDGE
p. 112 | 115



SAINT BARTH
p. 116 | 119



MINI ISLAND
p. 120 | 123



MAKE-UP
p. 124 | 127



NAIL NAT
p. 128 | 131



NAIL NAT LED
p. 128 | 131



LIVING
p. 132 | 135



LIVING LED
p. 132 | 135

MOBILI E ARREDI
FURNITURE

COMPLEMENTI E ACCESSORI
FURNITURE AND ACCESSORIES



NAT H20
p. 138 | 141



NAT 650 AIR
p. 138 | 141



NAT 1350 AIR
p. 142 | 145



NAT 1350 EARTH
p. 142 | 145



CARRELLO NAT
p. 194



CARRELLO CREO
p. 194



CARRELLO OBORO
p. 195



CARRELLO LIVING
p. 195



PANCA NAT
p. 146 | 149



NAT SOFA
p. 146 | 149



NAT
p. 150 | 155



CREO | CREO H20
p. 156 | 161



CARRELLO MADE
p. 196



CARRELLO SWING
p. 196



CARRELLO ARCUS
p. 197



SPECCHIO MAKE-UP
p. 197



SWING | SWING H20
p. 162 | 167



ET-NO | ET-NO H20
p. 168 | 173



RECEPTION LEI
p. 174 | 177



RECEPTION NAT
p. 178 | 181



CASSETTIERA LIVING
p. 198



CASSETTIERA NAIL NAT
p. 198



MENSOLA NAT
p. 200



MENSOLA SLIM
p. 200



RECEPTION NAT 16/9
p. 182 | 185



RECEPTION LIGHT
p. 186 | 191



VETRINETTA LIGHT
p. 186 | 191



MENSOLA STRATOS
p. 201



MENSOLA ARCUS
p. 201



SEDIA BRIO
p. 202



SGABELLO EASY
p. 202



SGABELLO FLEX
p. 203



ASPIRATORE HELIOS 280
p. 204



FILTRO HELIOS 280
p. 204



PIASTRA RISCALDANTE HOT
p. 205

LETTINI
MASSAGE BEDS

ARCUS	14
LUI LUI MOVER	20
LEI	26
NAT EVO PLUS	32
NAT EVO NAT EVO MOVER	38
VISION	44
SENSE SENSE MOVER	50
THE CLAIR	56
THE BEN THE BEN MOVER	62
E-MOTION 2.0	68
VIS	72
MADE	78
FLOW	84
LIVING	90
CREO	94
SWING	98
ANDROMEDA HYDRO	102



ARCUS

Il lusso del relax, la perfezione del design.

Un'icona di eleganza e raffinatezza, pensato per ambienti esclusivi dove il design incontra il benessere. La base in colore argento/dorata dona un tocco di prestigio e luminosità, trasformando ogni trattamento in un'esperienza di puro lusso. La struttura ergonomica assicura il massimo comfort, rendendo ogni momento di relax un vero rituale di benessere.

The luxury of relaxation, the perfection of design.

An icon of elegance and sophistication, designed for exclusive settings where design meets wellness. The silver/gold-colored base adds a touch of prestige and brightness, transforming every treatment into an experience of pure luxury. The ergonomic structure ensures maximum comfort, making every moment of relaxation a true wellness ritual.





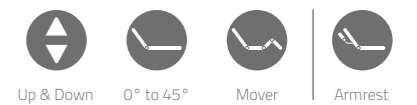

FINITURA | FINISH
Basamento argento/dorato
 Matt silver/gold base



Finitura ovale colori skai premium
 Premium skai oval colours finish



VIS 51N VIS 53N VIS 63N VIS 70N VIS 71N



OPTIONAL | ACCESSORIES

- Materasso riscaldato
- Braccioli regolabili
- Materasso 850 mm
- Colore skai materasso
- Heated mattress
- Adjustable armrests
- Mattress 850 mm
- Skai colours mattress

DIMENSIONI (mm) | DIMENSIONS (mm)

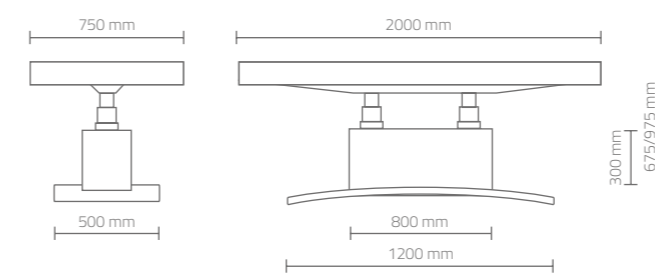

Letto per massaggi elettrico con doppia colonna, dotato di quattro motori. Si tratta di un lettino multifunzionale che si presta a qualsiasi tipo di trattamento grazie alle sue innumerevoli regolazioni. I movimenti del materasso sono gestiti da un comodo telecomando. La struttura è di colore argento/dorato. La base e il materasso dotato di foro facciale con relativo tappo e portarotolo sono disponibili in 5 finiture skai premium.

Electric massage bed with a double column, equipped with four motors. This is a multifunctional bed suitable for any type of treatment thanks to its numerous adjustments. The movements of the mattress are controlled by a convenient remote control. The structure is silver/gold in color. The base and the mattress, equipped with a face hole with a corresponding plug and roll holder, are available in 5 premium skai finishes.



LUI | LUI MOVER

Stile deciso, comfort assoluto.

Il lettino Lui è pensato per chi cerca un'estetica sofisticata senza rinunciare alla comodità. La sua base, impreziosita da una trama geometrica in skai, conferisce un tocco di design esclusivo, trasformando ogni spazio in un'oasi di benessere. La struttura ergonomica garantisce un'accoglienza perfetta, per un relax senza compromessi.

Decisive style, absolute comfort.

Lui massage bed is designed for those seeking a sophisticated aesthetic without sacrificing comfort. Its base, enriched with a geometric pattern in skai, adds a touch of exclusive design, transforming any space into a wellness oasis. The ergonomic structure ensures perfect comfort for uncompromising relaxation.







LUI



LUI MOVER

VERSIONE CON MATERASSO CON BRACCIOLI
VERSION WITH MATTRESS WITH ARMRESTS

FINITURA | FINISH

Basamento bianco opaco

Matt white base



Finitura ovale colori skai premium

Premium skai oval colours finish



VIS 51N VIS 53N VIS 63N VIS 70N VIS 71N

Finitura ovale colori skai

Skai oval colours finish



VIS 10 VIS 11 VIS 18 VIS 30 VIS 32 VIS 34 VIS 40 VIS 42 VIS 44



OPTIONAL | ACCESSORIES

- Materasso riscaldato
- Braccioli regolabili
- Materasso 850 mm
- Colore skai materasso

- Heated mattress
- Adjustable armrests
- Mattress 850 mm
- Skai colours mattress

DIMENSIONI (mm) | DIMENSIONS (mm)

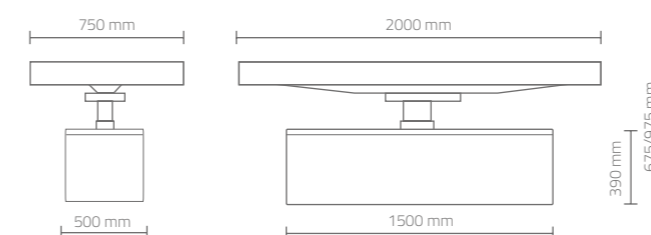

Letto per massaggi elettrico mono-colonna con piano bianco opaco e base rivestita in skai trapuntato disponibile in 14 diverse finiture. Il materasso in skai bianco è dotato di foro facciale con relativo tappo e portarotolo. L'altezza del lettino e l'inclinazione dello schienale sono regolabili tramite l'utilizzo di un comodo telecomando. Disponibile anche nella versione con movimento Mover.

Electric massage bed with a single column, featuring a matte white laminated top and a base covered in quilted skai, available in 14 different finishes. The white skai mattress is equipped with a face hole with a corresponding plug and a roll holder. The height of the bed and the inclination of the backrest are adjustable using a convenient remote control. Also available in the version with Mover movement.



LEI

Eleganza e comfort in ogni dettaglio.

Il lettino Lei è un connubio di stile e benessere, perfetto per spa e centri benessere che desiderano offrire un'esperienza esclusiva. La sua base, rivestita in skai con una raffinata trama tridimensionale, dona carattere e prestigio all'ambiente, mentre la struttura ergonomica assicura il massimo comfort. Un mix di estetica e funzionalità per momenti di puro relax.

Elegance and comfort in every detail.

Lei massage bed is a blend of style and wellness, perfect for spas and wellness centers looking to offer an exclusive experience. Its base, covered in skai with a refined three-dimensional pattern, adds character and prestige to the setting, while the ergonomic structure ensures maximum comfort. A mix of aesthetics and functionality for moments of pure relaxation.







VERSIONE CON MATERASSO SENZA BRACCIOLI
VERSION WITH MATTRESS WITHOUT ARMRESTS

FINITURA | FINISH

Basamento bianco opaco

Matt white base



Finitura ovale colori skai premium

Premium skai oval colours finish



VIS 51N VIS 53N VIS 63N VIS 70N VIS 71N

Finitura ovale colori skai

Skai oval colours finish



VIS 10 VIS 11 VIS 18 VIS 30 VIS 32 VIS 34 VIS 40 VIS 42 VIS 44



OPTIONAL | ACCESSORIES

- Materasso riscaldato
- Braccioli regolabili
- Materasso 850 mm
- Colore skai materasso

- Heated mattress
- Adjustable armrests
- Mattress 850 mm
- Skai colours mattress

DIMENSIONI (mm) | DIMENSIONS (mm)

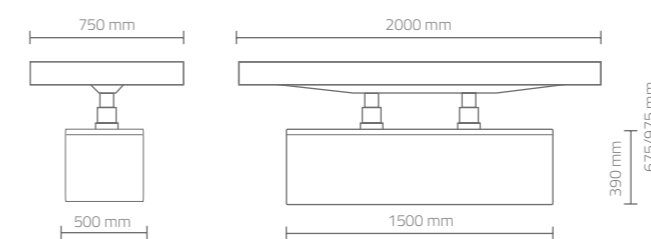

Letto per massaggi elettrico con doppia colonna, dotato di quattro motori. Si tratta di un lettino multifunzionale che si presta a qualsiasi tipo di trattamento grazie alle sue innumerevoli regolazioni. I movimenti del materasso sono gestiti da un comodo telecomando. Il lettino è realizzato con piano bianco opaco e base rivestita in skai trapuntato disponibile in 14 diverse finiture. Il materasso in skai bianco è dotato di foro facciale con relativo tappo e portarotolo.

Electric massage bed with a double column, equipped with four motors. This is a multifunctional bed suitable for any type of treatment thanks to its numerous adjustments. The movements of the mattress are controlled by a convenient remote control. The bed is made with a matte white top and a base covered in quilted skai, available in 14 different finishes. The white skai mattress is equipped with a face hole with a corresponding plug and a roll holder.



NAT EVO PLUS

Un'esperienza di benessere su misura.

Eleganza, comfort e funzionalità si incontrano in questo lettino elettrico a doppia colonna, dotato di quattro motori per regolazioni precise e intuitive. Progettato per offrire il massimo della versatilità, ogni trattamento diventa un rituale su misura, grazie alle regolazioni gestibili con semplicità tramite un pratico telecomando. Ogni dettaglio è pensato per garantire il massimo del relax e della personalizzazione.

A tailor-made wellness experience.

Elegance, comfort and functionality come together in this double-column electric massage bed, equipped with four motors for accurate and intuitive adjustments. Designed to offer maximum versatility, each treatment becomes a tailor-made ritual, thanks to the adjustments that can be easily managed via a handy remote control. Every detail is designed to ensure maximum relaxation.







VERSIONE CON MATERASSO SENZA BRACCIOLI
VERSION WITH MATTRESS WITHOUT ARMRESTS



FINITURA | FINISH

Bordo lamina di acciaio spazzolato
Brushed steel plate border



Finitura nobilitato
Melamine faced finish

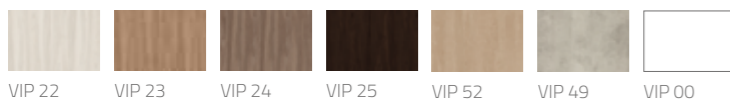

OPTIONAL | ACCESSORIES

- Materasso riscaldato
- Braccioli regolabili
- Materasso 850 mm
- Colore skai materasso

- Heated mattress
- Adjustable armrests
- Mattress 850 mm
- Skai colours mattress

DIMENSIONI (mm) | DIMENSIONS (mm)

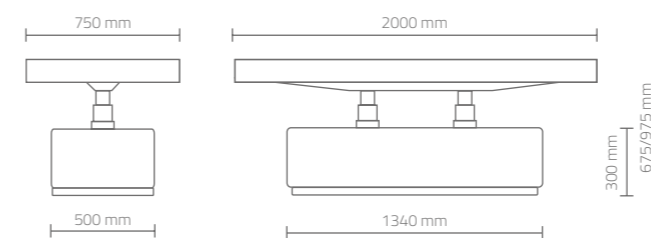

Letto per massaggi elettrico con doppia colonna, dotato di quattro motori. Si tratta di un lettino multifunzionale che si presta a qualsiasi tipo di trattamento grazie alle sue innumerevoli regolazioni. I movimenti del materasso sono gestiti da un comodo telecomando. È realizzato in nobilitato disponibile in 7 diverse finiture. Il materasso, in skai bianco, è dotato di foro facciale con relativo tappo e portarotolo. Il basamento è dotato di anta a ribalta e può essere utilizzato come mobile per il posizionamento di accessori.

Electric massage bed with two columns, equipped with four motors. It is a multifunctional massage bed suitable for any type of treatment thanks to its countless adjustments. The movement of the mattress are managed by a remote control. It is made of melamine faced-board, available in 7 different finishes. The mattress, made of white skai, is equipped with facial hole with cap and roll holder. The base is equipped with a folding door and can be used as a piece of furniture for accessories positioning.

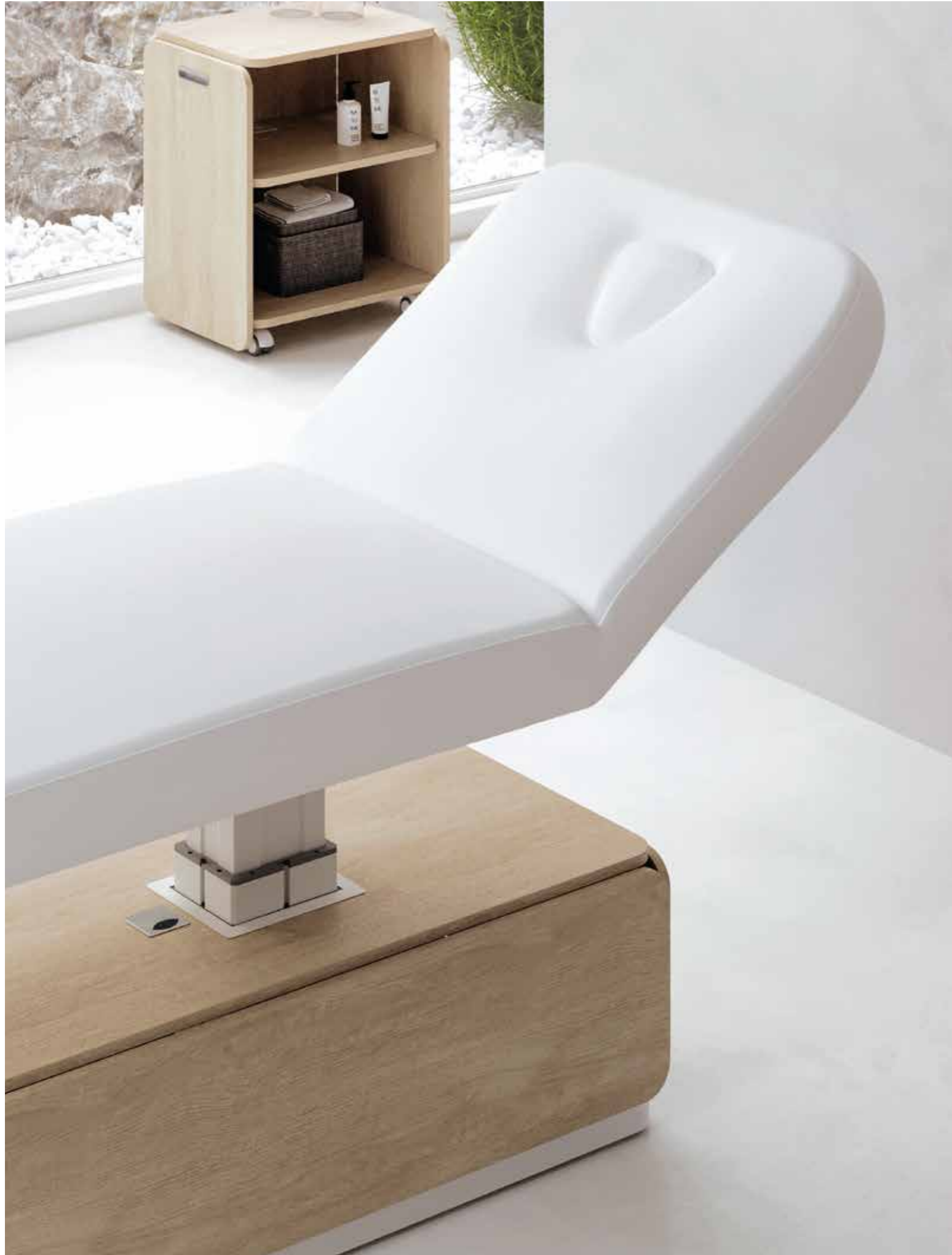

NAT EVO | NAT EVO MOVER

L'equilibrio perfetto tra estetica, praticità e benessere.

Con il suo design raffinato e la struttura nobilitata dalle eleganti finiture, Nat Evo è il lettino elettrico che unisce stile e praticità. Il morbido materasso in skai bianco, con foro facciale, assicura il massimo comfort, mentre il telecomando permette di regolare altezza e inclinazione con facilità. Il basamento con anta a ribalta offre spazio per accessori, garantendo ordine e funzionalità in ogni trattamento.

The perfect balance between aesthetics, practicality and wellness.

With its refined design and melamine structure with elegant finishes, Nat Evo is the electric massage bed that combines style and practicality. The soft white skai mattress, with face hole, ensures maximum comfort. The remote control allows you to easily adjust height and inclination. The base with flap door offers a tidy space for accessories, ensuring functionality in every treatment.







NAT EVO



NAT EVO MOVER

VERSIONE CON MATERASSO SENZA BRACCIOLI
VERSION WITH MATTRESS WITHOUT ARMRESTS

FINITURA | FINISH

Bordo lamina di acciaio spazzolato
Brushed steel plate border



Finitura nobilitata
Melamine faced finish



VIP 22 VIP 23 VIP 24 VIP 25 VIP 52 VIP 49 VIP 00



OPTIONAL | ACCESSORIES

- Materasso riscaldato
- Braccioli regolabili
- Materasso 850 mm
- Colore skai materasso
- Heated mattress
- Adjustable armrests
- Mattress 850 mm
- Skai colours mattress

DIMENSIONI (mm) | DIMENSIONS (mm)

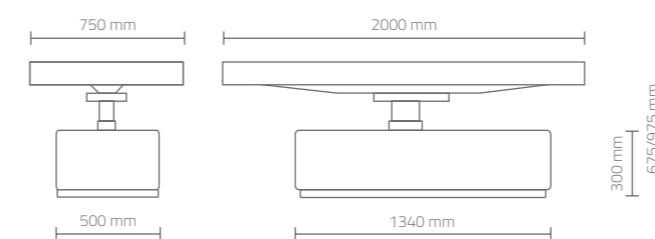

Letto per massaggi elettrico mono-colonna realizzato in nobilitato disponibile in 7 diverse finiture. Il materasso in skai bianco è dotato di foro facciale con relativo tappo e portarotolo. L'altezza del lettino e l'inclinazione dello schienale sono regolabili tramite l'utilizzo di un comodo telecomando. Il basamento è dotato di anta a ribalta e può essere utilizzato come mobile per il posizionamento di accessori. Disponibile anche nella versione con movimento Mover.

Electric massage bed with one column, made of melamine faced-board, available in 7 different finishes. The mattress, made of white skai, is equipped with facial hole with cap and roll holder. The height of the bed and the backrest inclination are adjustable using a convenient remote control. The base is equipped with a folding door and can be used as a piece of furniture for accessories positioning. Also available with Mover movement.



VISION

Il lusso al servizio del benessere.

Vision è un lettino elettrico a doppia colonna che unisce eleganza e potenza. Con quattro motori silenziosi e potenti, offre regolazioni precise e senza sforzo, facilmente gestibili tramite telecomando. Il materasso in skai bianco, completo di foro facciale e portarotolo, garantisce il massimo comfort, mentre la versione con braccioli regolabili assicura una personalizzazione totale. Ogni trattamento diventa un'esperienza che va oltre la funzionalità: è puro piacere estetico e sensoriale.

Luxury and wellness.

Vision is a double-column electric massage bed that combines elegance and power. With four noiseless and powerful motors, it offers precise adjustments, easily managed via remote control. The white skai mattress, with face hole and roll holder, guarantees maximum comfort, while the version with adjustable armrests ensures total customization. Each treatment becomes an experience that goes beyond functionality: it is pure aesthetic and sensory pleasure.



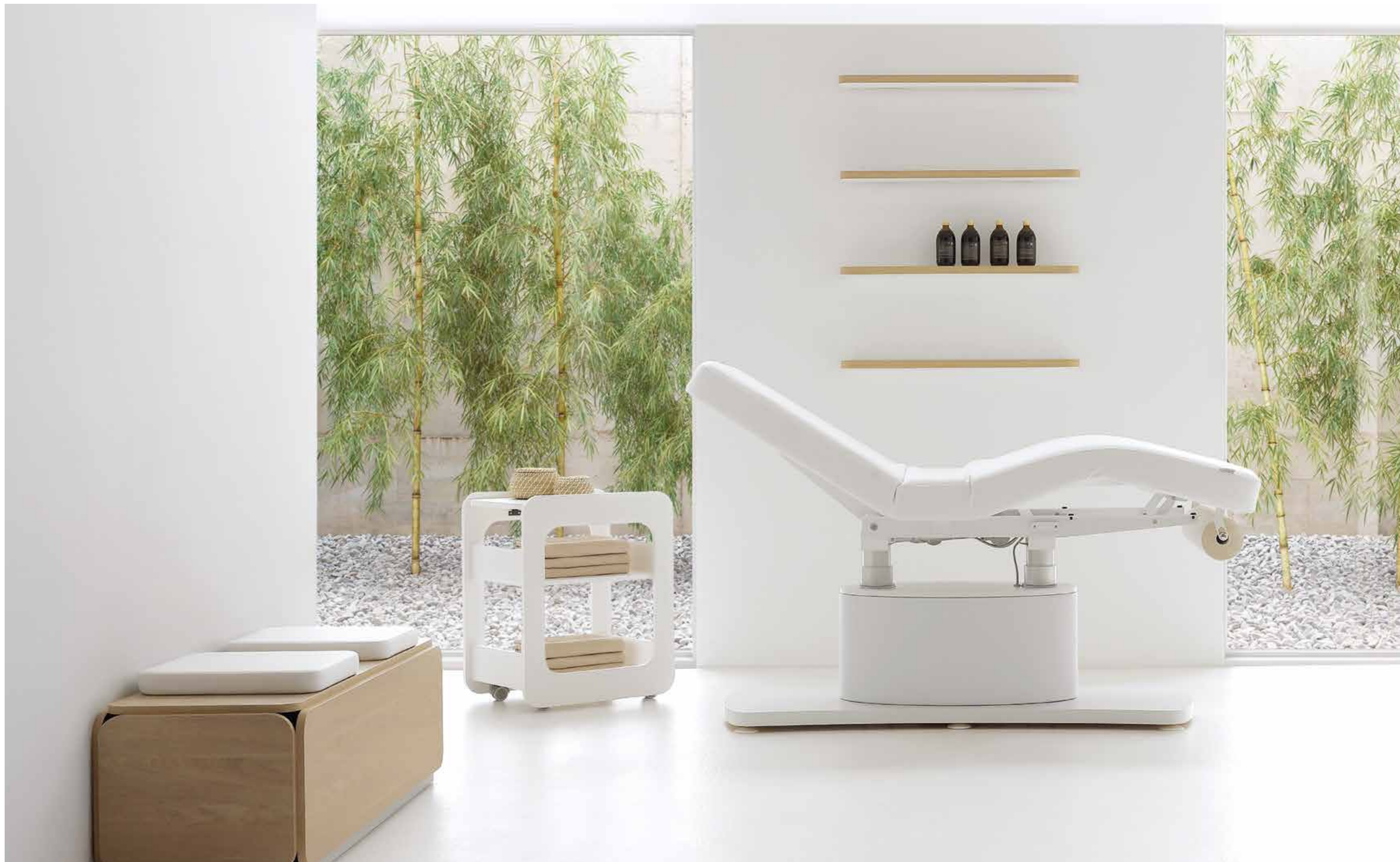



VERSIONE CON MATERASSO SENZA BRACCIOLI
VERSION WITH MATTRESS WITHOUT ARMRESTS

FINITURA | FINISH

Basamento bianco opaco

Matt white base



Finitura ovale colori skai premium

Premium skai oval colours finish



VIS 51N VIS 53N VIS 63N VIS 70N VIS 71N

Finitura ovale colori skai

Skai oval colours finish



VIS 10 VIS 11 VIS 18 VIS 30 VIS 32 VIS 34 VIS 40 VIS 42 VIS 44



OPTIONAL | ACCESSORIES

- Materasso riscaldato
- Braccioli regolabili
- Materasso 850 mm
- Colore skai materasso

- Heated mattress
- Adjustable armrests
- Mattress 850 mm
- Skai colours mattress

DIMENSIONI (mm) | DIMENSIONS (mm)

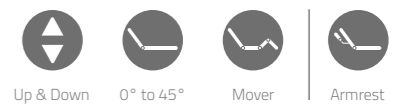
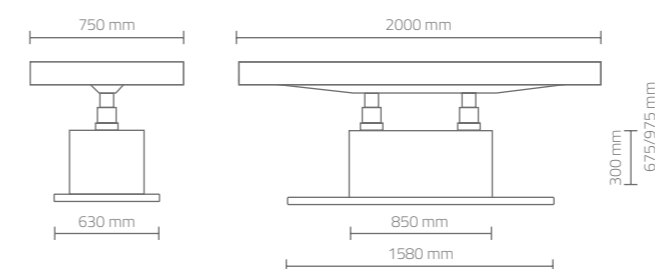

Letto per massaggi elettrico con doppia colonna, dotato di quattro motori. Si tratta di un letto multifunzionale che si presta a qualsiasi tipo di trattamento grazie alle sue innumerevoli regolazioni. I movimenti del materasso sono gestiti da un comodo telecomando. Il materasso, in skai bianco, è dotato di foro facciale con relativo tappo e portarotolo ed è disponibile anche nella versione con braccioli regolabili. Il basamento è bianco opaco e l'ovale è rivestito in skai disponibile in 14 colori.

Electric massage bed with double column, equipped with four motors. It is a multifunctional massage bed suitable for any type of treatment thanks to its countless adjustments. The movement of the mattress is managed by a remote control. The mattress, made of white skai, is equipped with facial hole with cap and roll holder and it is also available with adjustable armrests. The base is matt white and the oval part is covered in skai available in 14 colours.



SENSE | SENSE MOVER

L'armonia perfetta tra estetica e benessere.

Pensato per chi cerca il massimo del benessere, Sense è un lettino elettrico a mono-colonna che unisce eleganza e funzionalità. Il morbido materasso in skai bianco, con foro facciale e tappo, accoglie il corpo in un abbraccio rilassante. Disponibile anche nella versione con braccioli regolabili, si adatta perfettamente a ogni esigenza garantendo un'esperienza su misura.

The perfect harmony between aesthetics and wellness.

Designed for those seeking maximum wellness, Sense is a single-column electric massage bed that combines elegance and functionality. The soft white skai mattress, with face hole and cap, welcomes the body in a relaxing embrace. Also available in the version with adjustable armrests, it perfectly adapts to every need, ensuring a tailor-made experience.







SENSE



SENSE MOVER

VERSIONE CON MATERASSO SENZA BRACCIOLI
VERSION WITH MATTRESS WITHOUT ARMRESTS

FINITURA | FINISH

Basamento bianco opaco

Matt white base



Finitura ovale colori skai premium

Premium skai oval colours finish



VIS 51N VIS 53N VIS 63N VIS 70N VIS 71N

Finitura ovale colori skai

Skai oval colours finish



VIS 10 VIS 11 VIS 18 VIS 30 VIS 32 VIS 34 VIS 40 VIS 42 VIS 44



OPTIONAL | ACCESSORIES

- Materasso riscaldato
- Braccioli regolabili
- Materasso 850 mm
- Colore skai materasso

- Heated mattress
- Adjustable armrests
- Mattress 850 mm
- Skai colours mattress

DIMENSIONI (mm) | DIMENSIONS (mm)

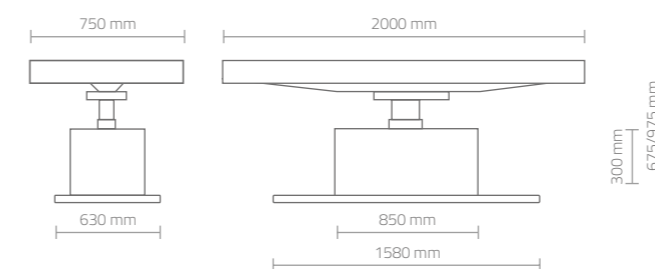

SENSE è un lettino per massaggi elettrico, mono-colonna, con materasso in skai bianco dotato di foro facciale con relativo tappo e portarotolo, disponibile anche nella versione con braccioli regolabili. La regolazione dell'altezza e dello schienale avviene tramite telecomando. Il basamento è bianco opaco e l'ovale è rivestito in skai disponibile in 14 colori. Disponibile anche nella versione con movimento Mover.

SENSE is an electric massage bed with one column, with white skai mattress, equipped with facial hole and relative cap and roll holder, and it is also available with adjustable armrests. The height regulation and the backrest inclination are managed by a remote control. The base is matt white and the oval part is covered in skai available in 14 colours. Also available with Mover movement.



THE CLAIR

Il lettino che ridefinisce il concetto di benessere.

Con The Clair, il benessere non è solo una promessa, ma una realtà. Questo lettino elettrico multifunzionale, dotato di quattro motori, offre infinite opzioni di regolazione per adattarsi perfettamente a qualsiasi tipo di trattamento. Il movimento elettrico delle due colonne e del materasso è facilmente gestibile, per un comfort assoluto. Non solo funzionale, ma anche pensato per rendere ogni trattamento un momento di puro piacere e rilassamento.

The massage bed that redefines the concept of wellness.

With The Clair, wellness is not just a promise, but a reality. This multifunctional electric massage bed, equipped with four motors, offers endless adjustment options to perfectly adapt to any type of treatment. The electric movement of the two columns and the mattress is easily managed, for absolute comfort. Not only functional, but also designed to make each treatment a moment of pure pleasure and relaxation.







VERSIONE CON MATERASSO CON BRACCIOLI
VERSION WITH MATTRESS WITH ARMRESTS

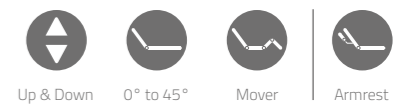

FINITURA | FINISH

Struttura bianco opaco
Matt white structure



Finitura nobilitato
Melamine faced finish



VIP 22 VIP 23 VIP 24 VIP 25 VIP 52 VIP 49 VIP 04 VIP 00



OPTIONAL | ACCESSORIES

- Materasso riscaldato
- Braccioli regolabili
- Materasso 850 mm
- Colore skai materasso
- Heated mattress
- Adjustable armrests
- Mattress 850 mm
- Skai colours mattress

DIMENSIONI (mm) | DIMENSIONS (mm)

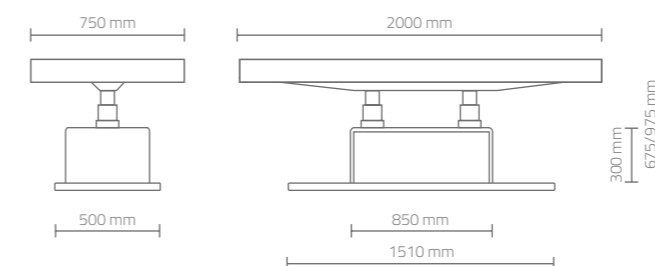

Letto elettrico multifunzionale dotato di quattro motori, che offre diverse opzioni di regolazioni. Il movimento elettrico delle due colonne e del materasso è gestito da un telecomando per agevolare qualsiasi tipo di trattamento. Basamento bianco opaco con vano contenitivo dotato di anta a ribalta disponibile in 8 finiture. Il materasso in skai bianco è disponibile anche nella versione con braccioli regolabili.

The Clair is a multifunctional electric massage bed equipped with four motors, which offers different adjustment options. The electric movement of the two columns and of the mattress is controlled by remote control and facilitates any type of treatment. The basement is matt white and it has a compartment with a flap door available in 8 different finishes. The mattress in white skai is available with or without adjustable armrests.



THE BEN | THE BEN MOVER

L'essenza del benessere.

The Ben è un lettino elettrico monocolonna, dotato di due motori, che diventa l'alleato ideale per ogni operatore. La regolazione semplice dell'altezza e dello schienale offre il massimo comfort e supporto, per ogni tipo di trattamento. Il design elegante del basamento bianco opaco, disponibile in diverse finiture raffinate, arricchisce ogni ambiente. Un lettino che trasforma ogni massaggio in un'esperienza di benessere totale, senza compromessi.

The essence of wellness.

The Ben is a single-column electric massage bed, equipped with two motors, which becomes the ideal ally for every operator. The height and backrest adjustment offers maximum comfort and support, for every type of treatment. The elegant design of the matt white base, available in different refined finishes, enriches any location. A massage bed that transforms every massage into a total wellness experience, without compromise.







VERSIONE CON MATERASSO CON BRACCIOLI
VERSION WITH MATTRESS WITH ARMRESTS

FINITURA | FINISH

Struttura bianco opaco
Matt white structure



Finitura nobilitato
Melamine faced finish

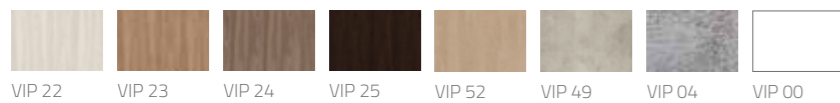

OPTIONAL | ACCESSORIES

- Materasso riscaldato
- Braccioli regolabili
- Materasso 850 mm
- Colore skai materasso
- Heated mattress
- Adjustable armrests
- Mattress 850 mm
- Skai colours mattress

DIMENSIONI (mm) | DIMENSIONS (mm)

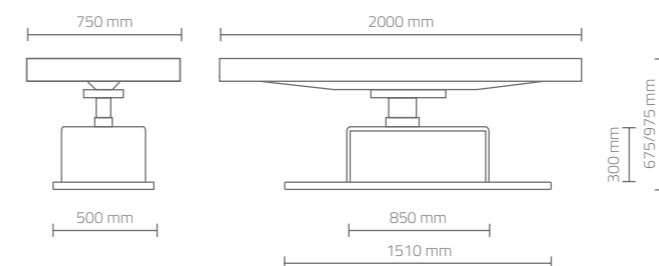

Letto elettrico da massaggio monocolonna, dotato di due motori. La regolazione dell'altezza e dello schienale avviene tramite telecomando per facilitare il lavoro dell'operatore. Basamento bianco opaco con vano contenitivo dotato di anta a ribalta disponibile in 8 finiture. Il materasso in skai bianco è disponibile anche nella versione con braccioli regolabili. Disponibile anche nella versione con movimento Mover.

Electric massage bed with one column, equipped with two motors. Height and backrest adjustment by means of remote control in order to facilitate any type of treatment. The basement is matt white and it has a compartment with a flap door available in 8 different finishes. The mattress, in white skai, is also available with adjustable armrests. Also available with Mover movement.



E-MOTION 2.0

Innovazione e comfort in ogni movimento.

E-Motion 2.0 unisce design, funzionalità e praticità in un unico prodotto. Il basamento in finitura bianco opaco conferisce eleganza e semplicità, mentre il materasso a profilo sagomato con lo schienale, regolabile manualmente in posizioni da 0° a 45°, consente di personalizzare ogni trattamento. La colonna, regolabile elettricamente in altezza tramite un comodo comando a pedale, permette di offrire la massima praticità e versatilità. Un alleato indispensabile per trasformare ogni trattamento in un'esperienza di benessere su misura.

Innovation and comfort in every movement.

E-Motion 2.0 combines design, functionality and practicality in a single product. The base in matt white finish gives elegance and simplicity. The shaped profile mattress with the backrest, manually adjustable in positions from 0° to 45°, allows to customize each treatment.

The column, electrically adjustable in height by means of a convenient pedal control, allows you to offer maximum practicality and versatility. An indispensable ally to transform every treatment into a tailor-made wellness experience.



E-motion è un lettino per massaggi elettrico con basamento in finitura bianco opaco. Rivestimento materasso in skai bianco. Colonna regolabile in altezza elettricamente con comando a pedale. Materasso a profilo sagomato, foro facciale con relativo tappo e portarotolo. Schienale regolabile manualmente a 0°, 15°, 30°, 45°.

Electric massage bed with base in matt white laminate. Shaped mattress covered by white skai, facial opening with cap and roll holder. Adjustable column by electrical pedal control. Adjustable backrest at 0°, 15°, 30°, 45°.



Up & Down 0° to 45°

FINITURA | FINISH

Struttura e basamento bianco opaco
Matt white base and structure



DIMENSIONI (mm) | DIMENSIONS (mm)

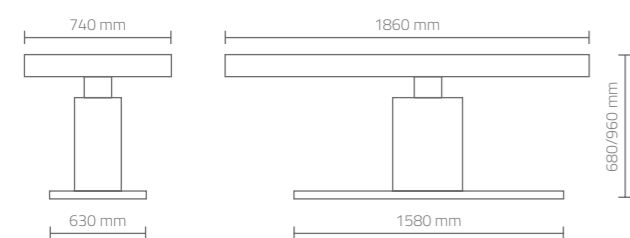



VIS

Il benessere che si adatta al tuo stile.

Eleganza e funzionalità si fondono in Vis, il lettino realizzato in nobilitato. Il piano d'appoggio, con finitura coordinata alla struttura, aggiunge un tocco di classe a ogni ambiente. Il materasso in skai bianco, completo di foro facciale con tappo e portarotolo, garantisce il massimo del comfort. Per un'esperienza ancora più lussuosa, è possibile richiedere il materasso riscaldato, per aggiungere un tocco di calore e relax a ogni trattamento.

Wellness that suits your style.

Elegance and functionality come together in Vis, the massage bed made of melamine faced board. The support surface, with coordinated finish, adds a touch of class to any room. The white skai mattress, with facial hole with cap and roll holder, guarantees maximum comfort. For an even more luxurious experience, you can request the heated mattress, to add a touch of warmth and relaxation to each treatment.







FINITURA | FINISH

Struttura bianco opaco
Matt white structure



Finitura nobilitato
Melamine faced finish



VIP 22 VIP 52 VIP 00



OPTIONAL | ACCESSORIES

- Materasso riscaldato
- Heated mattress

DIMENSIONI (mm) | DIMENSIONS (mm)

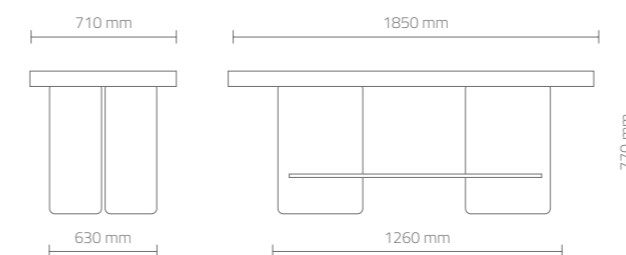

0° to 45°

Vis è un lettino per massaggi realizzato in finitura bianco opaco con piano d'appoggio disponibile in 3 diverse finiture. Il materasso in skai bianco è dotato di foro facciale, relativo tappo e portarotolo. La testata è regolabile manualmente.

Vis is a massage bed realized in matt white finish with a shelf on the base available in 3 different finishes. The mattress, in white skai, is equipped with facial hole with cap and roll holder. The headrest is manually adjustable.



MADE

Dove eleganza e comfort si incontrano.

Eleganza, qualità e praticità si fondono in Made, il lettino realizzato in nobilitato. Il materasso a profilo sagomato, con foro facciale e tappo, garantisce il massimo comfort, mentre lo schienale regolabile manualmente consente di adattare il lettino alle esigenze specifiche di ogni cliente. Made è pensato per offrire un'esperienza di benessere unica, su misura per ogni trattamento.

Elegance and comfort come together.

Elegance, quality and practicality come together in Made, the massage bed made of melamine faced board. The shaped profile mattress, with facial hole and cap, ensures maximum comfort, while the manually adjustable backrest allows the massage bed to be adapted to the specific needs of each customer. Made is designed to offer a unique wellness experience, tailored to each treatment.







VIP 00



VIP 24



VIP 52

FINITURA | FINISH

Struttura bianco opaco
Matt white structure



Finitura nobilitato
Melamine faced finish



VIP 22 VIP 52 VIP 00



OPTIONAL | ACCESSORIES

- Materasso riscaldato
- Heated mattress

DIMENSIONI (mm) | DIMENSIONS (mm)

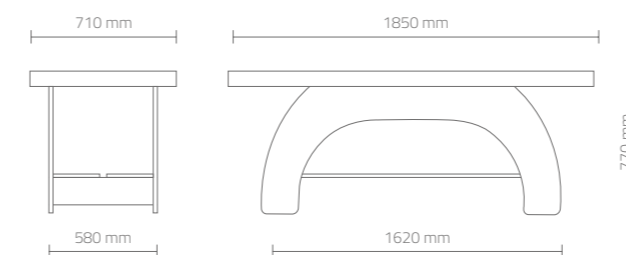

Made è un lettino per massaggi realizzato in finitura bianco opaco con piano d'appoggio disponibile in 3 diverse finiture. Il materasso in skai bianco è dotato di foro facciale, relativo tappo e portarotolo. La testata è regolabile manualmente.

Made is a massage bed realized in matt white finish with a shelf on the base available in 3 different finishes. The mattress, in white skai, is equipped with facial hole with cap and roll holder. The headrest is manually adjustable.



0° to 45°



FLOW

Eleganza che fluisce in ogni trattamento.

Eleganza e comfort si incontrano in Flow, il lettino realizzato in nobilitato. Il piano d'appoggio, con finitura coordinata alla struttura, arricchisce ogni ambiente con un design raffinato. Il materasso in skai bianco con testata regolabile manualmente in diverse posizioni, consente di adattare il lettino alle necessità specifiche di ogni cliente, offrendo il massimo supporto e personalizzazione. Per un'esperienza ancora più lussuosa, è disponibile, il materasso riscaldato, che aggiunge un tocco di calore e relax a ogni trattamento.

Elegance flowing into every treatment.

Elegance and comfort meet in Flow, the massage bed made of melamine faced board. The top, with finish coordinated with the structure, enriches any room with a refined design. The white skai mattress with manually adjustable headboard in different positions allows the bed to be adapted to the specific needs of each customer, offering maximum support and customization. The heated mattress can be chosen for a luxurious experience, which adds a touch of warmth and relaxation to each treatment.







VIP 22



VIP 23



VIP 24



VIP 25

FINITURA | FINISH

Finitura nobilitato
Melamine faced finish

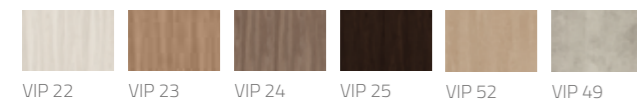

VIP 22 VIP 23 VIP 24 VIP 25 VIP 52 VIP 49



OPTIONAL | ACCESSORIES

- Materasso riscaldato
- Heated mattress

DIMENSIONI (mm) | DIMENSIONS (mm)

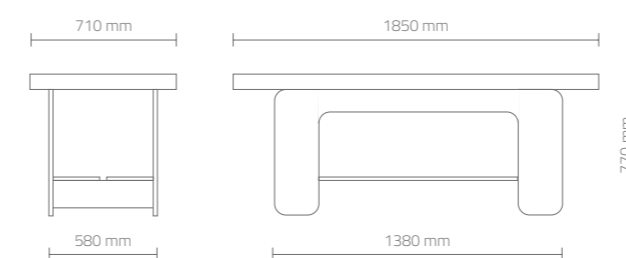

0° to 45°

Letto per massaggi Flow realizzato in nobilitato disponibile in 6 diverse finiture. Dotato di piano d'appoggio con finitura coordinata alla struttura. Il materasso in skai bianco è dotato di foro facciale con relativo tappo e portarotolo. È possibile richiedere, come optional, il materasso riscaldato. La testata è regolabile manualmente in diverse posizioni.

Flow massage bed with structure in melamine faced-board. Available in 6 different finishes. It is equipped with shelf support with matching finish. White mattress with facial hole and cap and roll holder. Heated mattress as option. The headrest is manually adjustable.



LIVING

Ogni massaggio diventa un'esperienza unica.

Living, realizzato con finitura bianco opaco e piano d'appoggio disponibile in eleganti varianti, è pensato per adattarsi perfettamente a qualsiasi ambiente. Il materasso in skai bianco, dotato di foro facciale, tappo e portarotolo, garantisce un comfort ottimale durante ogni trattamento. La testata, regolabile manualmente, permette di personalizzare ogni esperienza, offrendo il massimo del supporto e della praticità.

Each massage becomes a unique experience.

Living has a matt white finish structure and shelves available in elegant variants. It is designed to adapt perfectly to any location. The white skai mattress, equipped with a face hole, cap and roll holder, guarantees optimal comfort during each treatment. The manually adjustable headboard allows you to customize every experience, offering maximum support and practicality.



Living è un lettino per massaggi realizzato in finitura bianco opaco con piano d'appoggio disponibile in 3 diverse finiture. Il materasso in skai bianco è dotato di foro facciale, relativo tappo e portarotolo. La testata è regolabile manualmente.

Living is a massage bed realized in matt white finish with a shelf on the base available in 3 different finishes. The mattress, in white skai, is equipped with facial hole with cap and roll holder. The headrest is manually adjustable.



0° to 45°

FINITURA | FINISH

Struttura bianco opaco
Matt white structure



Finitura nobilitata
Melamine faced finish



VIP 22 VIP 52 VIP 00

OPTIONAL | ACCESSORIES

- Materasso riscaldato
- Heated mattress



DIMENSIONI (mm) | DIMENSIONS (mm)

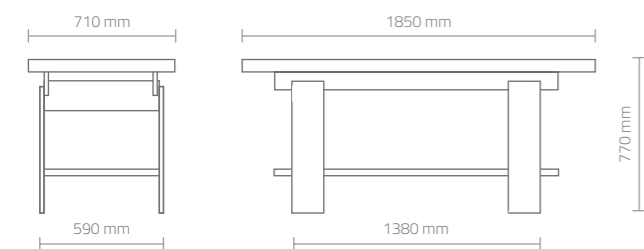



CREO

Il lettino che dà forma al tuo benessere.

Creo è un lettino che trasforma ogni trattamento in un'esperienza di puro benessere. La sua struttura dalle linee curve e sinuose dona un aspetto unico e affascinante, capace di arricchire ogni ambiente con eleganza e stile. Il materasso, con testata regolabile manualmente in diverse posizioni, si adatta perfettamente alle esigenze di ogni cliente, offrendo il massimo del comfort. Il piano d'appoggio consente una personalizzazione totale, creando un angolo di serenità su misura.

The massage bed that shapes your well-being.

Creo is a massage bed that transforms every treatment into an experience of pure wellness. Its structure with curved and sinuous lines gives a unique and fascinating appearance, able to enrich any location with elegance and style. The mattress, with a manually adjustable headboard in different positions, perfectly adapts to the needs of each customer, offering maximum comfort. The support surface allows total customization, creating a tailor-made corner of serenity.



Creo è un lettino per massaggi in finitura bianco opaco con una struttura dalle linee curve e sinuose che gli conferiscono un aspetto originale e unico. Il materasso è realizzato in skai bianco ed è dotato di foro facciale, relativo tappo e portarotolo. La testata è regolabile manualmente in diverse posizioni. È dotato di piano d'appoggio disponibile in 3 diverse finiture.

Creo is a massage bed with matt white structure with curved and sinuous lines that give an original and unique appearance. The mattress, made of white skai, is equipped with facial hole with cap and roll holder. The headrest is manually adjustable in different positions. It is equipped with a shelf on the base available in 3 different finishes.



0° to 45°

FINITURA | FINISH

Struttura bianco opaco
Matt white structure



Finitura nobilitato
Melamine faced finish



VIP 22 VIP 52 VIP 00

OPTIONAL | ACCESSORIES

- Materasso riscaldato
- Heated mattress



DIMENSIONI (mm) | DIMENSIONS (mm)

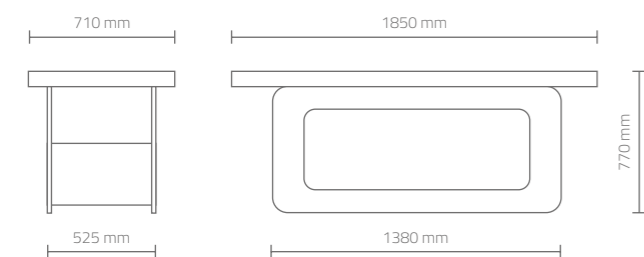



SWING

Eleganza e versatilità in un design sofisticato.

Realizzato in nobilitato bianco opaco, con dettagli disponibili in diverse finiture, Swing dona un tocco moderno e raffinato a ogni ambiente. È dotato di due pratici cassetti, un piano estraibile per macchinari e vani espositivi per prodotti, offrendo una soluzione perfetta per organizzare e accedere facilmente agli strumenti di lavoro. Il capiente vano di ampie dimensioni permette di riporre attrezzature in modo ordinato, mantenendo l'ambiente sempre impeccabile.

Elegance and versatility in a sophisticated design.

Made of matt white melamine faced board, with front details available in different finishes, Swing gives a modern and refined touch to any location. It is equipped with two practical drawers, a pull-out shelf for machinery and compartments for products, offering a perfect solution for organizing and easily accessing work tools. The large compartment allows you to store equipment, keeping the room always impeccable.



Swing è un lettino per massaggi realizzato in nobilitato bianco opaco con particolari disponibili in 3 diverse finiture. Swing è dotato di due cassetti, piano estraibile per macchinari, due vani espositivi per prodotti, vano di ampie dimensioni dove poter posizionare attrezzature estetiche, rotoli, termo coperta ecc. Materasso a profilo sagomato, foro facciale e relativo tappo rivestito in skai bianco. Schienale regolabile manualmente e porta rotolo.

Massage bed made of matt white melamine-faced board with details available in 3 different finishes. Swing bed is equipped with two drawers, pull-down shelf for beauty equipments, two expositive compartments for products, big compartment for equipments, rolls, electric blanket, etc. Shaped mattress and facial opening with cap covered by white skai. Manually adjustable backrest and roll holder.



0° to 45°

FINITURA | FINISH

Struttura bianco opaco
Matt white structure



Finitura nobilitato
Melamine faced finish



VIP 22 VIP 52 VIP 00

DIMENSIONI (mm) | DIMENSIONS (mm)

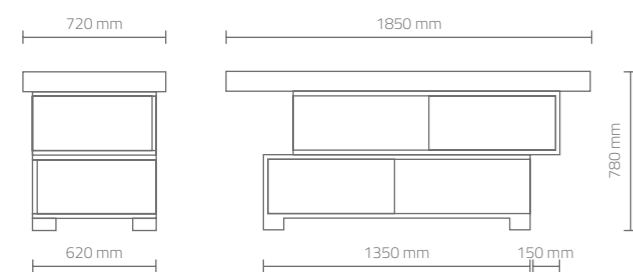

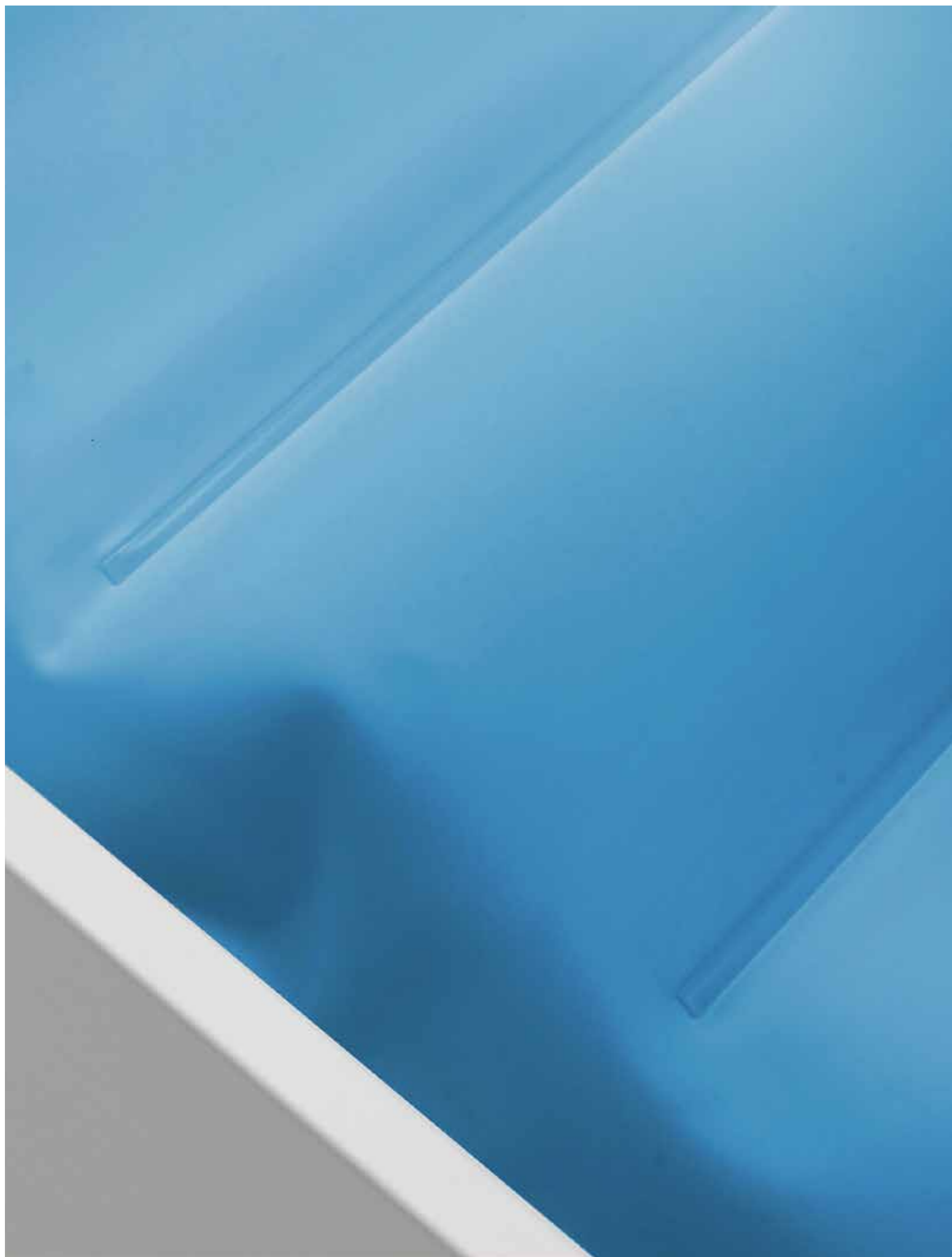

ANDROMEDA HYDRO

Dove il relax incontra il calore e la luce.

Andromeda Hydro è il lettino che porta l'esperienza del benessere a un livello superiore. Dotato di un esclusivo materasso ad acqua, composto da tre settori, offre un comfort incomparabile, avvolgendo il corpo in un abbraccio rilassante. Il piano riscaldante, con temperatura regolabile da 30 a 42 °C, permette di personalizzare ogni trattamento per un relax totale. Inoltre, Andromeda Hydro incorpora la funzione cromo relax, che unisce il potere terapeutico del calore alla cromoterapia, per un'esperienza multisensoriale unica.

Where relaxation meets warmth and light.

Andromeda Hydro brings the wellness experience to the next level. Equipped with an exclusive water mattress, consisting of three sectors, it offers incomparable comfort, enveloping the body in a relaxing embrace. The heating surface, with adjustable temperature from 30 to 42 °C, allows you to customize each treatment for total relaxation. In addition, Andromeda Hydro incorporates the chromo relax function, which combines the therapeutic power of heat with chromotherapy, for a unique multisensory experience.



Il lettino Andromeda Hydro è disponibile in laccato bianco opaco. Lettino dotato di materasso ad acqua composto da 3 settori. Il piano è riscaldante e la temperatura può variare da 30° a 42° C. Andromeda Hydro incorpora la funzione chromo relax.

Andromeda Hydro bed is available in matt white lacquered finish. This bed is equipped with a 3-sector water mattress. There is an heating system and the temperature can vary between 30° and 42° C. Andromeda Hydro bed incorporates chromo relax function.



Cromo Relax

FINITURA | FINISH

Struttura bianco opaco

Matt white structure



DIMENSIONI (mm) | DIMENSIONS (mm)

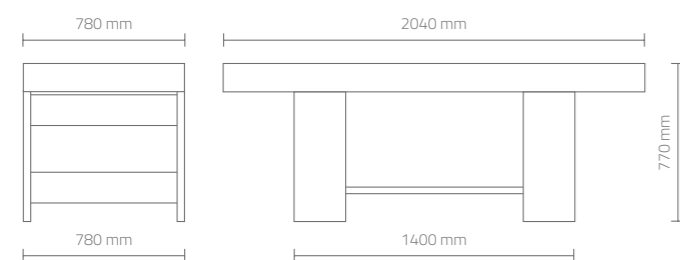

ISOLE
BEAUTY CORNERS

TAHITI	108
EDGE	112
SAINT BARTH	116
MINI ISLAND	120
MAKE-UP	124
NAIL NAT NAIL NAT LED	128
LIVING LIVING LED	132



TAHITI

Ogni dettaglio è studiato per offrire un benessere completo.

Tahiti è una poltrona dal design moderno, creata per combinare comfort e funzionalità senza compromessi sull'estetica. La sua ampia seduta, disponibile in una varietà di colori, garantisce un'accoglienza perfetta. È dotata di un pratico vano estraibile che include una vaschetta rimovibile per trattamenti pedicure. Lo schienale e il morbido poggiatesta sono facilmente regolabili grazie a un sistema a pompa a gas, assicurando così il massimo relax.

Every detail is designed to offer complete wellness.

Tahiti is an armchair with a modern design, created to combine comfort and functionality without compromising on aesthetics. Its wide seat, available in a variety of colors, ensures perfect comfort. It is equipped with a practical removable compartment that includes a detachable basin for pedicure treatments. The backrest and the soft footrest are easily adjustable thanks to a gas pump system, ensuring maximum relaxation.



Tahiti offre una seduta ampia e confortevole, personalizzabile in 9 varianti di colore skai. Il poggiatesta è regolabile per adattarsi alle diverse esigenze. Dispone di un pratico vano estraibile che include una vaschetta rimovibile per trattamenti pedicure. Il morbido poggiatesta e lo schienale sono entrambi regolabili tramite un sistema a pompa a gas, garantendo il massimo comfort e versatilità.

Tahiti offers a wide and comfortable seat, customizable in 9 different skai colour variations. The headrest is adjustable to suit different needs. It features a practical removable compartment that includes a removable basin for pedicure treatments. The soft footrest and backrest are both adjustable via a gas pump system, ensuring maximum comfort and versatility.

FINITURA | FINISH

Finitura colori skai
Skai colours finish



DIMENSIONI (mm) | DIMENSIONS (mm)

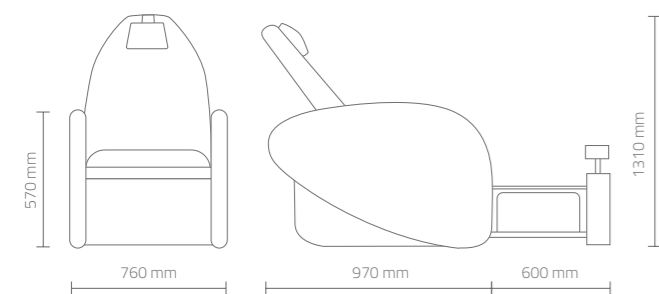

VASCA ESTRAIBILE
POGGIAPIEDI REGOLABILE
REGOLAZIONE ALTEZZA POGGIATESTA
INCLINAZIONE SCHIENALE

REMOVABLE BASIN
ADJUSTABLE FOOTREST
HEADREST ADJUSTABLE IN HEIGHT
RECLINABLE BACKREST





EDGE

Ogni dettaglio per un benessere totale.

Edge è una poltrona dal design moderno e sinuoso, pensata per garantire comfort e funzionalità senza rinunciare all'estetica. La sua ampia seduta, personalizzabile in diversi colori, offre un'accoglienza perfetta mentre i braccioli sollevabili e il poggiatesta regolabile in altezza permettono di adattarla ad ogni esigenza. Il basamento bianco opaco con bordo in acciaio spazzolato aggiunge eleganza, mentre la vaschetta per pedicure con doccetta garantisce un'esperienza di benessere completa. Perfetta per chi cerca la perfezione in ogni dettaglio.

Every detail for a total well-being.

Edge is a podo spa armchair with a modern and sinuous design, designed to ensure comfort and functionality without sacrificing aesthetics. Its wide seat, customizable in different colours, offers a perfect welcome while the rotating armrests and the height-adjustable headrest allow it to be adapted to every need. The matt white base with brushed steel rim adds elegance, while the pedicure basin with hand shower ensures a complete wellness experience. Perfect for those looking for perfection in every detail.



Edge è una moderna poltrona dalla linea sinuosa. Dotata di ampia e comoda seduta personalizzabile con 14 colori skai. La salita e la discesa sono agevolate dal sollevamento dei braccioli. Il poggiatesta è regolabile in altezza. Il basamento è bianco opaco con bordo acciaio spazzolato. La vaschetta per trattamenti pedicure è dotata di doccetta e miscelatore. Il morbido poggia piedi è regolabile sia in altezza che in profondità. Necessita allacciamento alla rete idrica.

Edge is a modern armchair with sinuous line. It is equipped with a wide comfortable seat that you can customize with 14 skai colors. Sit-down and get-up are facilitated by the armrest raising. The headrest is height adjustable. The basement is matt white with brushed steel border. The basin for pedicure treatments is equipped with shower and mixer tap. The soft footrest is adjustable both in height and depth. It is necessary to connect it to the water supply network.

FINITURA | FINISH

Basamento bianco opaco, profilo acciaio spazzolato
 Matt white basement, brushed stainless steel border



Finitura colori skai premium
 Premium skai colours finish

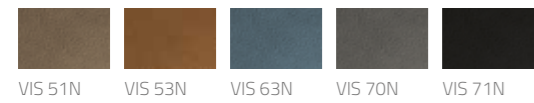

Finitura colori skai
 Skai colours finish



DIMENSIONI (mm) | DIMENSIONS (mm)

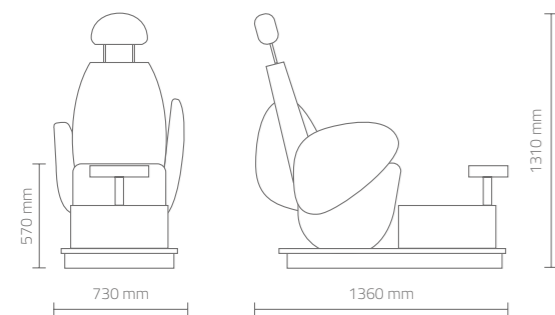

VASCA
 POGGIAPIEDI
 REGOLAZIONE ALTEZZA POGGIATESTA
 ROTAZIONE BRACCIOLI

BASIN
 FOOTREST
 HEADREST ADJUSTABLE IN HEIGHT
 ROTATING ARMREST

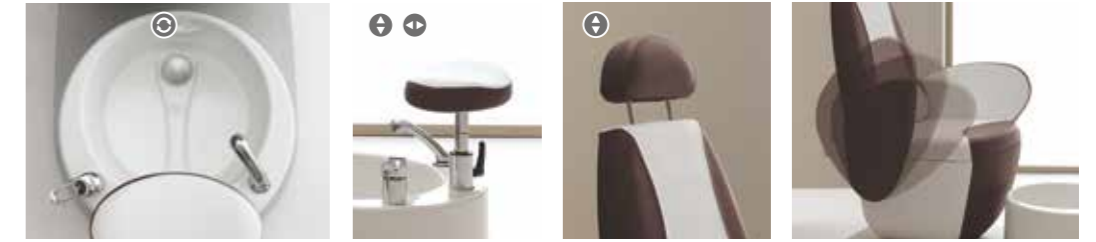



SAINT BARTH

Comfort senza compromessi, stile senza pari.

La poltrona Saint Barth è stata progettata per offrire un'esperienza di benessere senza compromessi, con una struttura ampia ed ergonomica che garantisce il massimo relax. I braccioli insieme alle pratiche vaschette removibili per manicure, migliorano ulteriormente il comfort. La seduta ruota a +/- 90 gradi, rendendo l'ingresso e l'uscita facili e comodi. L'innovativo massaggio ad aria assicura momenti di totale relax. Saint Barth è la perfetta combinazione di comfort, eleganza e funzionalità.

Unrivalled comfort and style.

Saint Barth podo spa armchair has been designed to offer an uncompromising wellness experience, with a wide and ergonomic seat that guarantees maximum relaxation. The armrests with practical manicure bowls further improve comfort. The seat rotates +/- 90 degrees, making it easy and comfortable to sit down and stand up. The innovative air massage ensures moments of total relaxation. Saint Barth is the perfect combination of comfort, elegance and functionality.



La poltrona Saint Barth è unica nel suo genere, ampia, ergonomica e confortevole. I braccioli e le relative vaschette removibili per manicure donano un maggior comfort al cliente. La rotazione della seduta avviene a +/- 90 gradi per agevolare seduta e discesa. La vasca, dotata di miscelatore con doccia, è realizzata in materiale compatto bianco ed è facilmente igienizzabile. Necessita di allaccio alla rete idrica. Il rivoluzionario massaggio ad aria garantisce un piacevole momento rilassante e richiede una sporadica manutenzione. L'ampio poggiatesta è regolabile in profondità e in altezza. È possibile personalizzare il colore del rivestimento skai.

Saint Barth armchair is wide comfortable and ergonomic. The arms are wider and also the removable bowls for manicure are larger. The headrest is adjustable for a total perfect relax. The seat can be rotated at +/-90 degrees so that it is easier sit down and get up. The basin equipped with mixer with hand shower, is made of compact white material and it is easy to clean. It requires main water. The revolutionary air whirlpool guarantees pleasant and relaxing moments asking only for a sporadic maintenance. The wide footrest is adjustable both in depth and in height. It's possible to choose the color of the skai upholstery.

FINITURA | FINISH

Basamento bianco opaco, profilo acciaio spazzolato
 Matt white basement, brushed stainless steel border



Finitura colori skai premium
 Premium skai colours finish

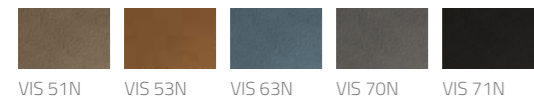

Finitura colori skai
 Skai colours finish



DIMENSIONI (mm) | DIMENSIONS (mm)

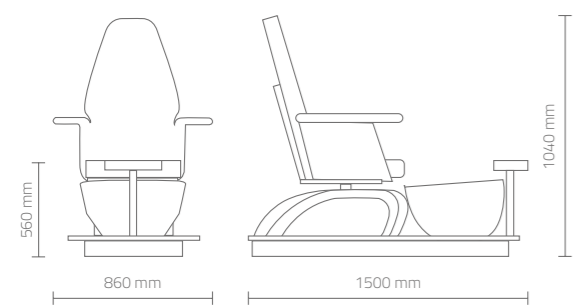

OPTIONAL | ACCESSORIES



Kit Idro Cromo
 Hydro&chrome Kit

MISCELATORE
 CROMO RELAX E IDROMASSAGGIO
 POGGIAPIEDI

MIXER TAP
 CROMO RELAX & WHIRLPOOL
 FOOTREST





MINI ISLAND

Dove il comfort incontra il design.

Mini Island è la poltrona podologica che trasforma ogni trattamento in un'esperienza unica. La sua seduta regolabile e la rotazione a 360° offrono una libertà totale, mentre lo schienale reclinabile e il poggiatesta regolabile assicurano un comfort su misura. Le vaschette per manicure aggiungono eleganza senza sacrificare lo spazio, mentre la vasca pedicure removibile rende tutto più semplice. Ogni dettaglio è pensato per un benessere totale, personalizzabile in ogni colore.

Where comfort meets design.

Mini Island is a podo spa chair that transforms every treatment into a unique experience. Its adjustable seat and 360° rotation offer total freedom, while the reclining backrest and adjustable headrest ensure tailored comfort. The practical manicure bowls add elegance without sacrificing space and can be hidden if necessary. The removable pedicure basin makes everything easier. Every detail is designed for total wellness, customizable in different colour.



La poltrona podologica Mini Island regala comfort grazie alla sua versatilità ed è estremamente curata in ogni particolare. Seduta regolabile in altezza, rotazione a 360°, schienale reclinabile con poggiatesta regolabile in altezza per un perfetto trattamento di benessere. Sono presenti due comode vaschette per manicure che all'occorrenza scompaiono sotto i braccioli per regalare maggior spazio e comfort. La vasca pedicure è removibile per un comodo caricamento dell'acqua. Il poggiaiedi funzionale è regolabile in altezza e in profondità. Il basamento è in multistrato con bordatura in micro lamina di acciaio spazzolato. Il pianale antigraffio è dotato di fermi in gomma per una maggiore stabilità della vasca pedicure. È possibile personalizzare il colore del rivestimento skai.

The podiatry chair Mini Island gives you comfort thanks to its versatility and it is well-finished in every detail. Adjustable seat in height, 360° degrees rotation, reclining backrest, height-adjustable headrest for a perfect wellness treatment. There are two comfortable bowls that can disappear under the armrests in order to leave more space. The pedicure basin is removable for an easier water charging. The practical footrest is adjustable in height and depth. The basement has a border in micro brushed steel plate. The scratchproof platform is equipped with rubber stoppers for a greater stability of the basin. It's possible to choose the color of the skai upholstery.

FINITURA | FINISH

Basamento bianco opaco, profilo acciaio spazzolato
 Matt white basement, brushed stainless steel border



Finitura colori skai
 Skai colours finish



DIMENSIONI (mm) | DIMENSIONS (mm)

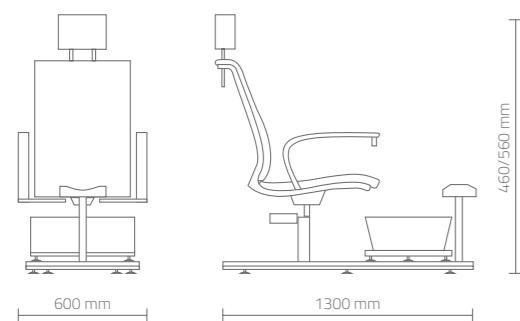

OPTIONAL | ACCESSORIES



Rialzo
 bianco opaco
 Matt white
 raised support

VASCHETTE MANICURE A SCOMPARSA
 REGOLAZIONE PROFONDITÀ E ALTEZZA POGGIAPIEDI
 REGOLAZIONE ALTEZZA POGGIATESTA
 INCLINAZIONE SCHIENALE

RETRACTABLE MANICURE BOWLS
 FOOTREST ADJUSTABLE IN DEPTH AND IN HEIGHT
 HEADREST ADJUSTABLE IN HEIGHT
 RECLINABLE BACKREST





MAKE-UP

Un angolo di stile per la bellezza.

La linea Make-Up è pensata per chi vive la bellezza come una vera arte, offrendo soluzioni che combinano eleganza, praticità e raffinatezza in ogni dettaglio. La Poltrona Make-Up, con il suo basamento cromato e la seduta regolabile, accoglie ogni movimento con il massimo del comfort. Il mobiletto Make-Up Cromo, pratico e stiloso, offre la possibilità di essere sospeso o montato su gambe cromate, per aggiungere un tocco di classe al tuo spazio. Infine, la specchiera Make-Up completa la linea con un design raffinato e un'illuminazione LED naturale, creando l'atmosfera ideale per ogni trattamento. Un angolo di bellezza che parla di stile e funzionalità, dove ogni dettaglio è pensato per ispirare il meglio.

A style corner for your beauty.

Make-Up line is designed for those who experience beauty as a true art, offering solutions that combine elegance, practicality and refinement in every detail. Make-Up Chair, with its chrome-plated base and adjustable seat, accommodates every movement with maximum comfort. The practical and stylish Make-Up Chrome cabinet offers the possibility of being suspended or mounted on chrome legs, to add a touch of class to the space. Finally, the Make-Up mirror completes the line with a refined design and natural LED lighting, creating the ideal atmosphere for each treatment. A beauty corner that speaks of style and functionality, where every detail is designed to inspire the best.



REGOLAZIONE ALTEZZA POGGIATESTA
INCLINAZIONE SCHIENALE
HEADREST ADJUSTABLE IN HEIGHT
RECLINABLE BACKREST



POLTRONA MAKE-UP
CHAIR MAKE-UP

Poltrona con basamento cromato di ampie dimensioni, seduta regolabile in altezza, rotazione a 360°, schienale reclinabile con poggiatesta regolabile in altezza. È possibile personalizzare il colore del rivestimento skai.

Make-up chair provided with a wide chrome-plated basement, height-adjustable seat, 360° degrees rotation, reclining backrest with height-adjustable headrest. It's possible to choose the color of the skai upholstery.

FINITURA | FINISH

Base in acciaio
Steel base



Finitura colori skai
Skai colours finish



VIS 10 VIS 11 VIS 18 VIS 30 VIS 32



VIS 34 VIS 40 VIS 42 VIS 44

DIMENSIONI (mm) | DIMENSIONS (mm)

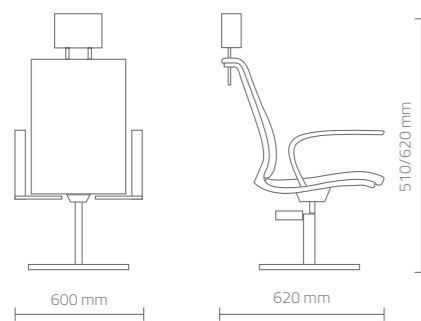

**BEAUTY CORNER MAKE-UP CROMO
E MAKE-UP MIRROR**
*BEAUTY CORNER MAKE-UP CROMO
AND MAKE-UP MIRROR*

Mobile Make-Up Cromo da trucco con struttura in legno nobilitato bianco opaco e cassetti frontali dotati di push-pull disponibili in 3 diverse finiture. Il mobiletto può essere sospeso o dotato di gambe cromate. Specchiera Make-Up Mirror con telaio in alluminio verniciato bianco. L'illuminazione a led ad alta potenza è celata dallo specchio diffondendo dal perimetro luce naturale per agevolare il lavoro dell'operatrice.

Make-up Cromo cabinet with structure in matt white melamine-faced board equipped with 2 push-pull drawers available in 3 different finishes. It can be suspended or equipped with 2 chrome-plated legs. Round wall mirror Make-Up with white lacquered aluminium frame. The high-potency Led lighting is concealed behind the mirror and spread out through its perimeter as natural light.

FINITURA | FINISH

Struttura bianco opaco
Matt white structure



Finitura nobilitato
Melamine faced finish



VIP 22 VIP 52 VIP 00

DIMENSIONI (mm) | DIMENSIONS (mm)

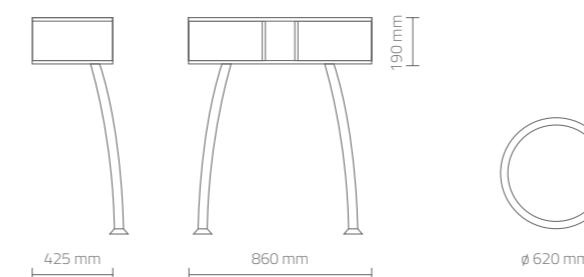



NAIL NAT | NAIL NAT LED

Funzionalità ed eleganza per la postazione manicure.

Essenziale, raffinato e studiato per offrire il massimo della praticità, il tavolo manicure NAIL NAT è realizzato in nobilitato bianco opaco. Il piano, con foro per aspiratore e mensola dedicata alle lampade UV, garantisce un ambiente di lavoro organizzato e funzionale, ideale per ogni professionista della bellezza.

Functionality and elegance for the manicure workstation.

Essential, refined and designed to offer maximum practicality, NAIL NAT manicure table is made of matt white melamine faced board. The table top with hole for aspirator and a shelf dedicated to UV lamps, guarantees an organized and functional work location, ideal for every beauty professional.





FINITURA | FINISH

Struttura bianco opaco
Matt white structure



DIMENSIONI (mm) | DIMENSIONS (mm)

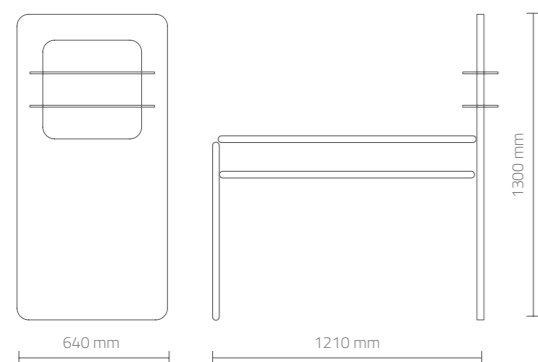

NAIL NAT

Tavolo professionale per manicure dalle dimensioni compatte realizzato in bianco opaco. È possibile creare una singola postazione o più postazioni di lavoro affiancando due o più moduli grazie all'innovativo sistema componibile. La struttura è inoltre dotata di foro passacavi, ideale per avere sempre una postazione ordinata e libera da fili e prese, in modo da garantire una migliore gestione dello spazio. Nail Nat è la versione semplice ed essenziale che offre la possibilità di scegliere tra il piano di lavoro classico oppure con il foro per l'aspirazione.

NAIL NAT LED

Il tavolo Nail Nat Led si differenzia dal precedente per la possibilità di aggiungere un modulo dotato di illuminazione a led composto da mensole satiniate su cui è possibile esporre smalti e prodotti.

NAIL NAT

A professional manicure table with compact dimensions, with a matte white structure. It is possible to create a single or multiple workstations by joining two or more modules thanks to the innovative modular system. The structure is also equipped with a cable pass-through hole, ideal for keeping the workstation tidy and free from wires and plugs, ensuring better space management. Nail Nat is the simple and essential version that offers the option to choose between a classic work surface or one with a hole for the vacuum system.

NAIL NAT LED

Nail Nat LED table differs from the previous one by offering the possibility of adding a module with LED lighting, composed of frosted shelves on which you can display nail polishes and products.

OPTIONAL | ACCESSORIES

CUSCINO POGGIAMANI - ASPIRATORE HELIOS 280
HAND CUSHION - HELIOS 280 ASPIRATOR



CASSETTIERA NAIL NAT
CHEST OF DRAWERS NAIL NAT



LIVING | LIVING LED

L'essenziale che rende il tuo spazio unico.

Living è molto più di un semplice tavolo da manicure: è la chiave per trasformare ogni angolo in un rifugio di stile e funzionalità. Realizzato con un elegante nobilitato bianco opaco, offre piani di lavoro in raffinate finiture, con la possibilità di personalizzare la lunghezza per adattarsi perfettamente al tuo spazio. La sua struttura componibile ti permette di creare postazioni multiple, mantenendo sempre l'ordine grazie al foro passacavi integrato. La versione Living Led aggiunge un tocco di luce rendendo ogni trattamento ancora più speciale.

The essential that makes your space unique.

Living is much more than a manicure table: it is the key to transforming every corner into a haven of style and functionality. Made of matt white melamine faced board, it offers worktops in refined finishes, with the possibility of customizing the length to perfectly fit your space. Its modular structure allows you to create multiple workstations, always maintaining order thanks to the integrated cable hole. The Living Led version adds a touch of light, making each treatment even more special.





FINITURA | FINISH

Struttura bianco opaco
Matt white structure



Finitura nobilitato
Melamine faced finish



VIP 22 VIP 52 VIP 00

DIMENSIONI (mm) | DIMENSIONS (mm)

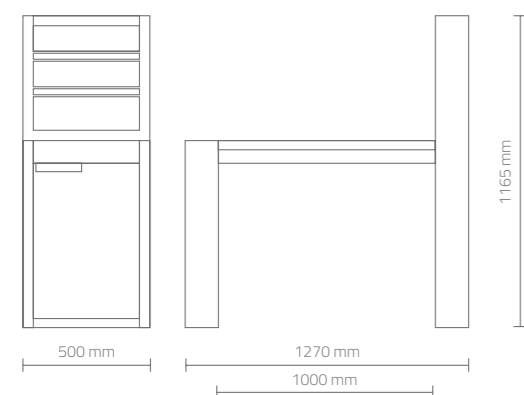
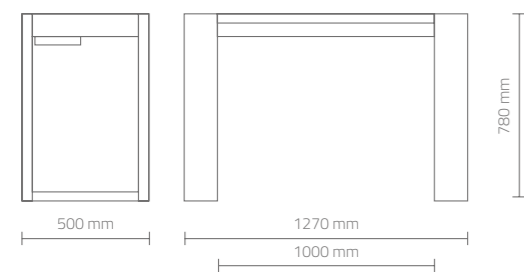

LIVING

Living è un tavolo professionale per manicure dalle dimensioni compatte realizzato in nobilitato bianco opaco, con piano disponibile in 3 diverse finiture.

È possibile creare una singola postazione o più postazioni di lavoro affiancando due o più moduli grazie all'innovativo sistema componibile. La struttura è inoltre dotata di foro passacavi, ideale per avere sempre una postazione ordinata e libera da fili e prese, in modo da garantire una migliore gestione dello spazio. Living è la versione semplice ed essenziale che offre la possibilità di scegliere tra il piano di lavoro classico oppure con il foro per l'aspirazione. Possibilità di personalizzazione del piano in lunghezza.

LIVING LED

Il tavolo Living Led si differenzia dal precedente per la possibilità di aggiungere un modulo dotato di illuminazione a led composto da mensole su cui è possibile esporre smalti e prodotti. Possibilità di personalizzare la misura del piano.

LIVING

Living is a professional manicure table with compact dimensions, made of matt white melamine-faced board and top available in 3 different finishes. It is possible to create a single workstation or a multiple workstations by adding two or more modules. You can customize it according to your needs thanks to the innovative modular system. The structure is also equipped with a cable channel hole, perfect to have always a tidy workstation, without any cable and sockets, in order to have more space and a better management of the work. Living is the simple and essential version of that table which offers the possibility to choose between the classic work table top or a top with hole for vacuum system. It is possible to customize the table top length.

LIVING LED

The Living Led table differs from the previous one because you can add a module equipped with Led lighting and display shelves for nail polishes and products. It is possible to customize the size of table top.

OPTIONAL | ACCESSORIES

CUSCINO POGGIAMANI - ASPIRATORE HELIOS 280
HAND CUSHION - HELIOS 280 ASPIRATOR



MOBILI E ARREDO

FURNITURE

NAT 650 AIR NAT H2O	138
NAT 1350 AIR EARTH	142
PANCA NAT NAT SOFA	146
NAT	150
CREO CREO H2O	156
SWING SWING H2O	162
ET-NO ET-NO H2O	168
RECEPTION LEI	174
RECEPTION NAT	178
RECEPTION NAT 16/9	182
RECEPTION LIGHT	186
VETRINETTA LIGHT	186



NAT 650 AIR | NAT H2O

Stile e funzionalità si incontrano, ogni dettaglio al suo posto.

NAT 650 AIR e NAT H2O sono la combinazione perfetta di eleganza e funzionalità, pensati per chi cerca un design semplice e raffinato. NAT H2O con il suo HPL bianco opaco e l'asola portasciugamano, lavabo e miscelatore risponde a ogni esigenza con stile. NAT 650 AIR arricchisce l'ambiente con un'anta a ribalta in diverse finiture, creando un angolo che trasmette qualità e armonia. Ogni dettaglio è pensato per rendere ogni spazio speciale.

Style and functionality come together, every detail in its place.

NAT 650 AIR and NAT H2O are the perfect combination of elegance and practicality, designed for those who seek a simple and refined design. NAT H2O, with its matte white HPL finish and eyelet for towel, basin, and faucet, meets every need with style. NAT 650 AIR enhances the space with a flip-down door available in various finishes, creating a corner that conveys quality and harmony. Every detail is crafted to make each space special.



NAT 650 AIR
NAT 650 AIR

Mobile a parete sospeso con anta a ribalta in nobilitato disponibile in 7 diverse finiture.

Hanging furniture made of melamine-faced board available in 7 different finishes with flap door.



FINITURA | FINISH

Finitura nobilitato
Melamine faced finish

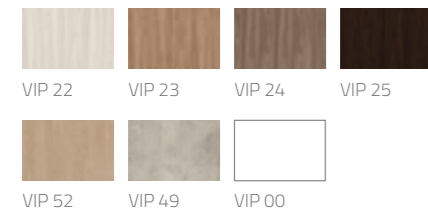

DIMENSIONI (mm) | DIMENSIONS (mm)

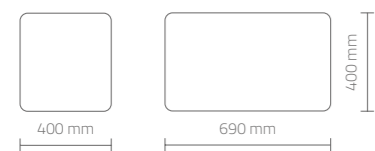

NAT H2O
NAT H2O

Mobile in HPL bianco opaco con asola portasciugamano. Possibilità di aggiungere lavabo e miscelatore (optional).

Wall furniture, matt white HPL, with eyelet for towel. It is possible to add the washbasin and the mixer tap (as option).

OPTIONAL | ACCESSORIES

LAVABO - MISCELATORE CON LEVA CLINICA
WASHBASIN - MIXER TAP



FINITURA | FINISH

Struttura bianco opaco
Matt white structure



DIMENSIONI (mm) | DIMENSIONS (mm)





NAT 1350 AIR | EARTH

In ogni finitura, un tocco di classe.

NAT 1350 AIR e NAT 1350 EARTH sono l'espressione perfetta di un design contemporaneo e funzionale, pensato per chi ama la bellezza nei dettagli. NAT 1350 AIR, con la sua struttura sospesa, offre eleganza e praticità in ogni spazio, disponibile in diverse finiture per adattarsi perfettamente al tuo ambiente. NAT 1350 EARTH, con piedini marrone tiger, aggiunge un tocco di calore e sofisticatezza, garantendo una presenza forte e raffinata. Due soluzioni, un'unica promessa di qualità e stile senza compromessi.

In every finish, a touch of class.

NAT 1350 AIR and NAT 1350 EARTH are the perfect expression of a contemporary and functional design for those who love beauty in the details. NAT 1350 AIR, with its suspended structure, offers elegance and practicality in any space, available in different finishes to adapt perfectly to your environment. NAT 1350 EARTH, with tiger brown feet, adds a touch of warmth and sophistication, ensuring a strong and refined presence. Two solutions, a single promise of quality and style without compromise.





NAT 1350 AIR
NAT 1350 AIR

Mobile a parete sospeso con anta a ribalta in nobilitato disponibile in 7 diverse finiture.

Hanging furniture made of melamine-faced board available in 7 different finishes with flap door.



FINITURA | FINISH

Finitura nobilitato
Melamine faced finish

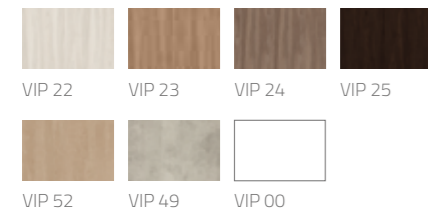

DIMENSIONI (mm) | DIMENSIONS (mm)

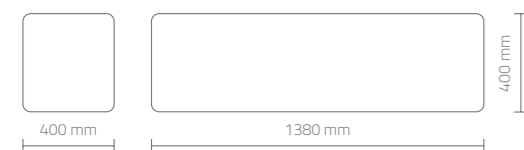

NAT 1350 EARTH
NAT 1350 EARTH

Mobile con anta a ribalta in nobilitato disponibile in 7 diverse finiture, con piedini in marrone tiger.

Furniture made of melamine-faced board available in 7 different finishes with flap door and tiger brown feet.



FINITURA | FINISH

Finitura nobilitato
Melamine faced finish

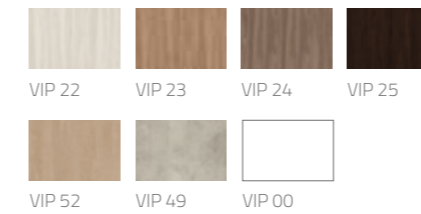

DIMENSIONI (mm) | DIMENSIONS (mm)





NAT | NAT SOFA

Il connubio perfetto tra stile e funzionalità.

Le panche NAT realizzate in nobilitato con bordo in acciaio spazzolato, sono disponibili in diverse finiture, regalando a ogni ambiente un tocco sofisticato e moderno. NAT SOFA aggiunge comfort alla bellezza, grazie alle sedute in skai, che rendono ogni momento di relax un'esperienza unica. Un connubio di design, funzionalità e stile che arricchisce ogni spazio.

The perfect combination of style and functionality.

NAT benches made of melamine faced board with brushed steel edge are available in different finishes, giving any environment a sophisticated and modern touch. NAT SOFA adds comfort to beauty, thanks to the skai seats, which make every moment of relaxation a unique experience. A combination of design, functionality and style that enriches any space.



NAT

Panca realizzata in nobilitato disponibile in 7 diverse finiture, con bordo a terra in lamina di acciaio spazzolato.

NAT SOFA

Panca realizzata in nobilitato disponibile in 7 diverse finiture, con bordo a terra in lamina di acciaio spazzolato. È dotata di sedute in skai.

NAT

Bench made of melamine faced-board available in 7 different finishes, with brushed steel plate border on the ground.

NAT SOFA

Bench made of melamine faced-board available in 7 different finishes, with brushed steel plate border on the ground. It is equipped with seats in skai.

FINITURA | FINISH

Bordo lamina di acciaio spazzolato

Brushed steel plate border



Finitura nobilitato

Melamine faced finish



VIP 22 VIP 23 VIP 24 VIP 25

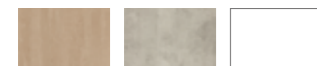

VIP 52 VIP 49 VIP 00

Finitura colori skai

Skai colours finish



VIS 10 VIS 11 VIS 18 VIS 30 VIS 32



VIS 34 VIS 40 VIS 42 VIS 44



DIMENSIONI (mm) | DIMENSIONS (mm)

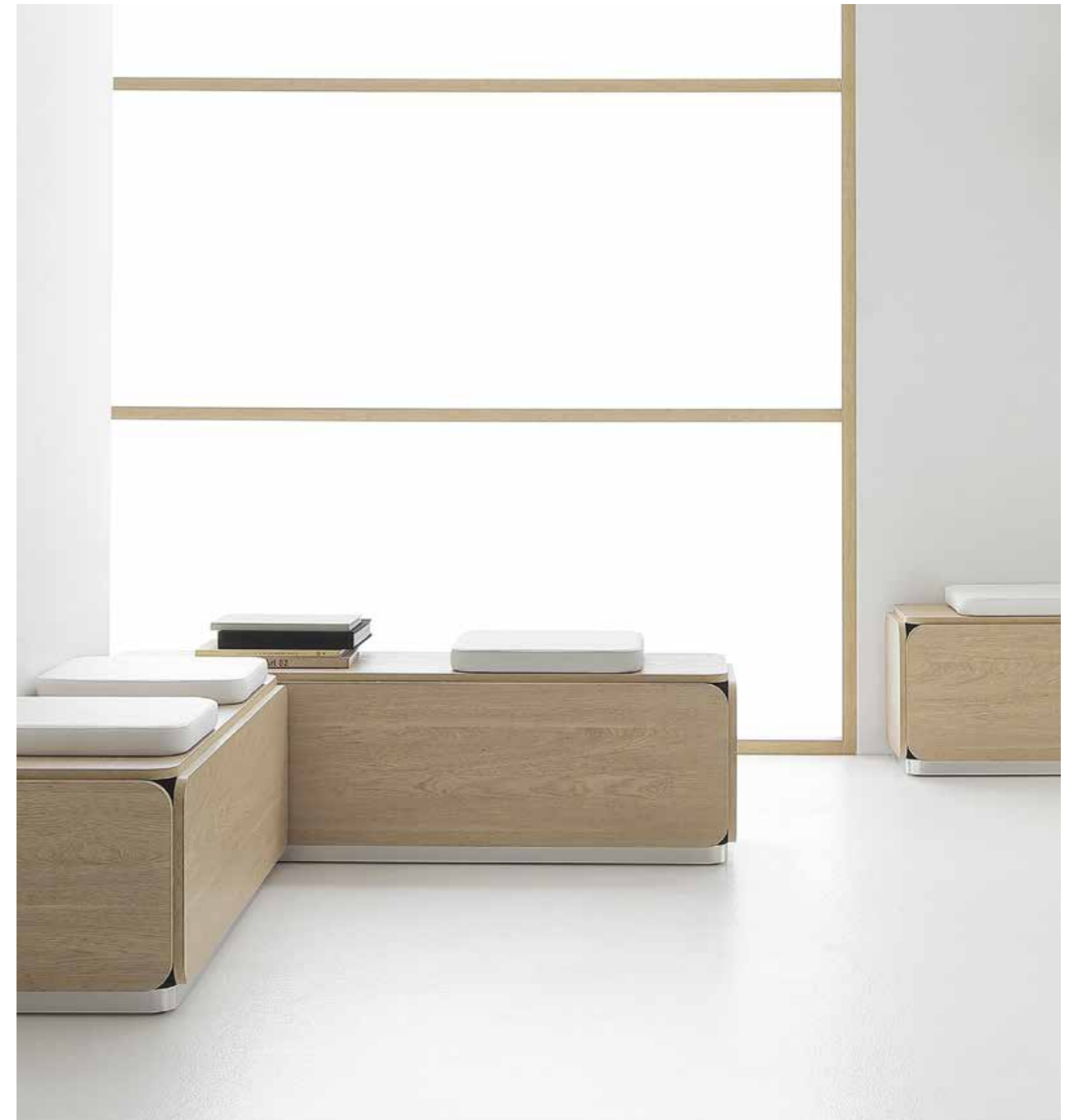
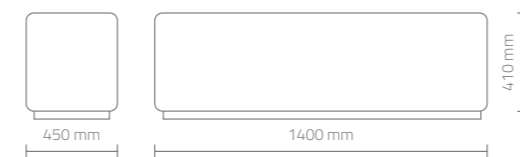
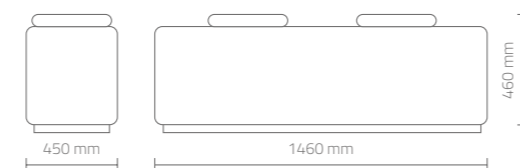



NAT

Armonia e funzionalità in ogni ambiente.

Il mobile NAT si distingue per le sue linee morbide e avvolgenti, che donano equilibrio e leggerezza a qualsiasi spazio. Realizzato in nobilitato bianco opaco, unisce estetica e praticità grazie ai suoi vani capienti e alle superfici dal design raffinato. Progettato per garantire il massimo comfort e funzionalità, adattandosi alle esigenze di ogni ambiente.

Harmony and functionality in every space.

NAT furniture stands out for its soft, enveloping lines that bring balance and lightness to any setting. Made of matte white melamine, it combines aesthetics and practicality with its spacious compartments and refined surfaces. Designed to ensure maximum comfort and functionality, it adapts seamlessly to the needs of every environment.







NAT 920



NAT 1360

FINITURA | FINISH

Struttura bianco opaco
Matt white structure



DIMENSIONI (mm) | DIMENSIONS (mm)

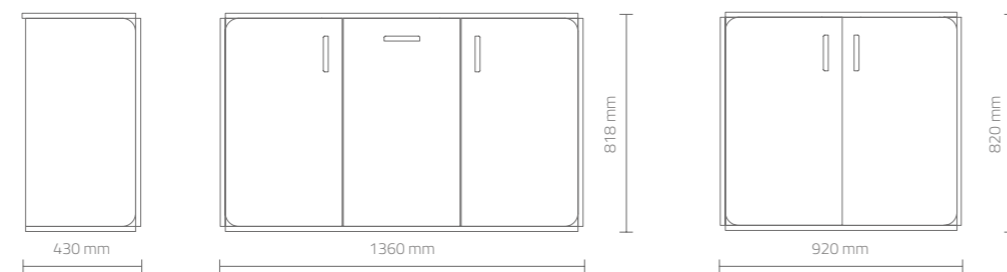

Nat 900 e 1350 sono mobili realizzati con struttura e frontali bianco opaco. Le ante sono dotate di comode maniglie in tinta.

Nat 900 e 1350 are furniture pieces featuring a matte white structure and fronts. The doors are equipped with matching-tone handles.



CREO | CREO H20

Dove il design si fonde con l'armonia.

I mobili Creo 900/1350 sono il perfetto equilibrio tra design e funzionalità. Con struttura bianco opaco e frontali in diverse finiture, aggiungono un tocco di eleganza a ogni spazio. I piedini in alluminio satinato e l'apertura push/pull delle ante e dei cassetti assicurano praticità e raffinatezza. Creo 900/1350 H20 si arricchisce con la versione lavabo, personalizzabile sia a destra che a sinistra, per adattarsi a ogni esigenza. Un miscelatore completa il design, rendendo ogni ambiente ancora più funzionale.

Where design merges with harmony.

Creo 900/1350 furniture is the perfect balance between design and functionality. With matt white structure and front details in different finishes, these furniture add a touch of elegance to any location. The satin aluminium feet and the push/pull opening of the doors and drawers, ensure practicality and refinement. Creo 900/1350 H20 is the model with the washbasin which can be positioned both on the right and left, for every need. A mixer tap completes the design, making each room even more functional.







CREO 900



CREO 1350



CREO 900 H2O



CREO 1350 H2O

FINITURA | FINISH

Struttura bianco opaco
Matt white structure



Finitura nobilitato
Melamine faced finish



VIP 22 VIP 23 VIP 24 VIP 25

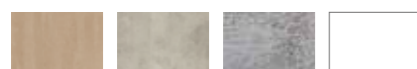

VIP 52 VIP 49 VIP 04 VIP 00

DIMENSIONI (mm) | DIMENSIONS (mm)

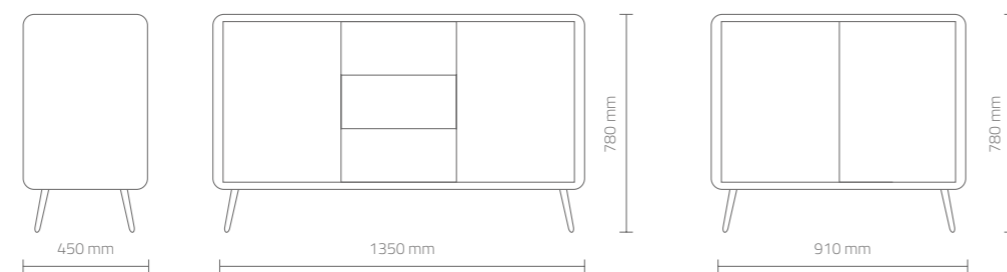

OPTIONAL | ACCESSORIES

- Miscelatore con leva clinica
- Mixer tap



CREO 900/1350

Creo 900 e 1350 sono mobili realizzati con struttura bianco opaco e frontali disponibili in 8 diverse finiture. I piedini sono in alluminio satinato e le ante ed i cassetti sono dotati di apertura push/pull.

CREO 900/1350 H2O

I mobili Creo 900 e 1350 sono disponibili anche nella versione con lavabo, posizionabile a destra o sinistra in base alle esigenze del cliente. Possibilità di aggiungere come optional il miscelatore a leva clinica.

CREO 900/1350

Creo 900 and 1350 are cabinets with matt white structure and front details available in 8 different finishes. The four feet are made of aluminium, satin finish. The doors and the drawers have push-pull opening.

CREO 900/1350 H2O

Creo 900 and 1350 are also available with washbasin. The client can choose the position (right or left) and there is also the possibility to add the clinical lever mixer tap.



SWING | SWING H20

Semplicità che sorprende, praticità che conquista.

Swing è il mobile dal design moderno e versatile, perfetto per ogni ambiente. Realizzato in nobilitato bianco opaco, con frontali in legno in eleganti finiture si adatta ad ogni stile. I quattro cassetti con apertura push/pull offrono praticità e raffinatezza, mentre la possibilità di personalizzare l'allineamento dei moduli permette di giocare con il design.

Swing H20 arricchisce lo spazio con la versione lavabo elegante e compatto, mentre il miscelatore a leva clinica aggiunge un tocco di praticità.

Simplicity that surprises, practicality that conquers.

Swing is the piece of furniture with a modern and versatile design, perfect for any location. Made of matt white melamine faced board, with wooden front details in elegant finishes, it adapts to any style. The four drawers with push/pull opening offer practicality and refinement, while the possibility of customizing the alignment of the modules allows you to play with the design.

Swing H20 enriches the space with the elegant and compact washbasin version, while the clinical lever mixer adds a touch of practicality.







SWING H2O



SWING

FINITURA | FINISH

Struttura bianco opaco
Matt white structure



Finitura nobilitato
Melamine faced finish



VIP 22 VIP 52 VIP 00

DIMENSIONI (mm) | DIMENSIONS (mm)

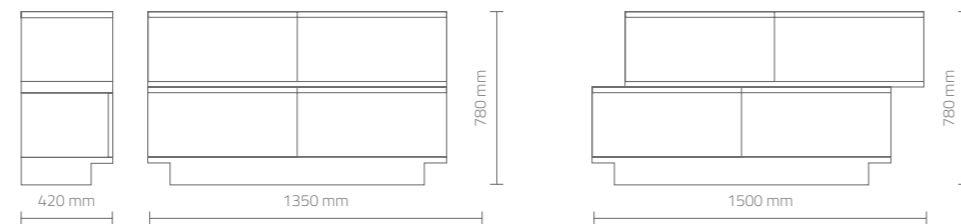

OPTIONAL | ACCESSORIES

- Miscelatore con leva clinica
- Mixer tap



SWING

Mobile dallo stile moderno e dalle linee semplici che si adatta ad ogni ambiente. Il mobile Swing è realizzato in nobilitato bianco opaco con frontali in legno disponibili in 3 diverse finiture. Swing è dotato di quattro cassetti con apertura push/pull. Il cliente può scegliere al momento del montaggio se posizionare il mobile in versione allineata oppure con la parte superiore decentrata rispetto a quella inferiore.

SWING H2O

Il mobile prende il nome di Swing H2O se scelto nella versione con lavabo. Misure lavabo L.400 x P.340 x H.145 mm. Swing H2O è dotato di tre cassetti con apertura push/pull. Il cliente può scegliere al momento del montaggio se posizionare il mobile in versione allineata oppure con la parte superiore decentrata rispetto a quella inferiore. Optional: miscelatore a leva clinica.

SWING

Piece of furniture with modern and simple lines that you can adaptable to any location. Swing is made of matt white melamine-faced board with details available in 3 different finishes. Swing is equipped with 4 push-pull drawers. During the assembling the client can choose to position the two parts of the furniture aligned or with the upper part decentralized than the lower one.

SWING H2O

The furniture takes the name Swing H2O if you choose the version with washbasin. Washbasin dimension L.400 X D.340 X H.145. Swing H2O is equipped with 3 push-pull drawers. During the assembling the client can choose to position the two parts of the furniture aligned or with the upper part decentralized than the lower one. Option: clinical lever mixer tap.



ET-NO | ET-NO H2O

La bellezza del legno, il comfort di ogni dettaglio.

Et-No e Et-No H2O sono mobili dal design moderno che trasformano ogni ambiente con originalità e stile. Realizzati in legno nobilitato, questi mobili sono completamente personalizzabili con ante e cassetti o vani a giorno. L'anta ammortizzata e le maniglie cromate, insieme alla praticità degli zoccolini, donano a ogni modello un perfetto equilibrio tra design e funzionalità. Et-No H2O offre la possibilità di integrare un lavabo compatto e raffinato, con un optional di miscelatore a leva clinica per la massima praticità.

The beauty of wood, the comfort of every detail.

Et-No and Et-No H2O are modern design furniture that transform every room with originality and style. Made of ennobled wood, these pieces of furniture are completely customizable with doors, drawers or open compartments. The soft-closing door and chrome handles, along with the practicality of the plinths, give each model a perfect balance between design and functionality. Et-No H2O offers the possibility of integrating a compact and refined basin, with an optional clinical lever mixer for maximum practicality.







ET-NO 450



ET-NO H2O 900



ET-NO 1350

FINITURA | FINISH

Struttura bianco opaco
Matt white structure



Finitura nobilitato
Melamine faced finish



VIP 22 VIP 23 VIP 24 VIP 25

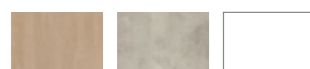

VIP 52 VIP 49 VIP 00

DIMENSIONI (mm) | DIMENSIONS (mm)

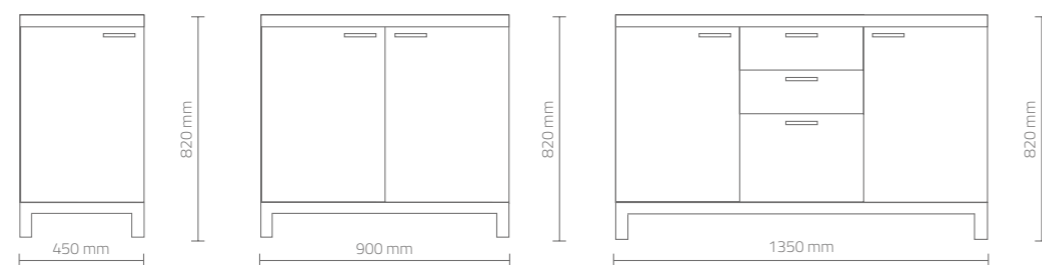

OPTIONAL | ACCESSORIES

- Miscelatore con leva clinica
- Mixer tap



Et-No e Et-No H2O sono mobili dallo stile moderno che permettono di arredare con originalità ogni ambiente. È possibile personalizzare il mobile a piacimento con ante e cassetti. Il piano e il basamento sono realizzati in bianco opaco, mentre la struttura è disponibile in 7 diverse finiture.

ET-NO 450 è dotato di un'anta con chiusura ammortizzata e maniglia cromata.
 ET-NO 900 è dotato di due ante con chiusura ammortizzata e maniglie cromate.
 ET-NO 1350 è dotato di due ante con chiusura ammortizzata, tre cassetti con guida a scomparsa con self-closing, e maniglie cromate.
 ET-NO H2O: il mobile prende il nome di Et-No H2O se scelto nella versione con lavabo. Misure lavabo L. 400 x P. 340 x H. 145 mm.
 Optional: miscelatore a leva clinica.

Et-No and Et-No H2O are modern-style furniture pieces that bring originality to any space. The unit can be customized with doors and drawers as desired. The top and base are finished in matte white, while the structure is available in 7 different finishes.

*ET-NO 450 features a soft-close door with a chrome handle.
 ET-NO 900 includes two soft-close doors with chrome handles.
 ET-NO 1350 is equipped with two soft-close doors, three drawers with concealed self-closing slides, and chrome handles.
 ET-NO H2O: the unit is named Et-No H2O when chosen with a built-in sink. Sink dimensions: L. 400 x D. 340 x H. 145 mm.
 Optional: clinical lever mixer tap.*



LEI

Stile deciso, accoglienza impeccabile.

La Reception Lei unisce design sofisticato e funzionalità, creando un punto d'incontro elegante e accogliente. La sua base, impreziosita da una trama geometrica in skai, aggiunge carattere e unicità, trasformando l'ambiente in uno spazio raffinato. Strutturata per garantire ordine e praticità, offre un'accoglienza impeccabile con dettagli curati e materiali di alta qualità.

Bold style, impeccable hospitality.

Lei reception desk combines sophisticated design and functionality, creating an elegant and welcoming focal point. Its base, adorned with a geometric skai pattern, adds character and uniqueness, transforming the space into a refined environment. Designed for organization and practicality, it ensures impeccable reception with carefully crafted details and high-quality materials.



Reception Lei realizzata con struttura bianco opaco e frontale in skai trapuntato disponibile in 14 diverse finiture. Dotata di cassetto con chiave, anta, vani a vista, passacavo e piano d'appoggio superiore. La base della reception è dotata di illuminazione led.

Lei reception desk features a matte white structure and a quilted skai front panel, available in 14 different finishes. It is equipped with a lockable drawer, a door, open compartments, cable pass-through hole, and an upper shelf. The base is equipped with LED lighting for a refined touch.

FINITURA | FINISH

Struttura bianco opaco

Matt white structure



Finitura colori skai premium

Premium skai colours finish



VIS 51N VIS 53N VIS 63N VIS 70N VIS 71N

Finitura colori skai

Skai colours finish



VIS 10 VIS 11 VIS 18 VIS 30 VIS 32



VIS 34 VIS 40 VIS 42 VIS 44

DIMENSIONI (mm) | DIMENSIONS (mm)





NAT

Il cuore organizzato di ogni ambiente.

La Reception NAT è la fusione perfetta di eleganza e funzionalità. Ogni dettaglio, realizzato in nobilitato e disponibile in diverse finiture, è pensato per offrire stile e ordine. Con il suo ampio piano d'appoggio, i vani a vista e un pratico cassetto con chiave, risponde a ogni esigenza di spazio e organizzazione. Il passacavo integrato assicura un ambiente sempre impeccabile, dove ogni visita inizia con l'accoglienza di un design curato e pratico, capace di impressionare e semplificare.

The organized heart of every environment.

NAT Reception is the perfect fusion of elegance and functionality. Every detail, made of melamine faced board, available in different finishes, is designed to offer style and order. With its large support surface, visible compartments and a practical drawer with key, it responds to every need for space and organization. The integrated cable passage ensures an always flawless environment. Every visit begins with the welcome of a refined and practical design, capable of impressing and simplifying.



Reception NAT realizzata in nobilitato disponibile in 7 diverse finiture. Dotata di cassetto con chiave, vani a vista, passacavo e piano d'appoggio superiore.

Reception NAT, made of melamine faced-board, available in 7 different finishes. It is equipped with one drawer with key, free compartments, cable entry and upper shelf.

FINITURA | FINISH

Finitura nobilitato
Melamine faced finish

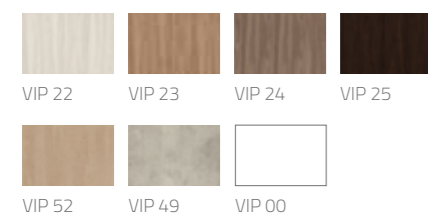

DIMENSIONI (mm) | DIMENSIONS (mm)





NAT 16/9

Eleganza e funzionalità per ogni accoglienza.

La Reception NAT 16/9 è la sintesi ideale di design raffinato e funzionalità. Realizzata in nobilitato e disponibile in diverse finiture, questa reception è progettata per rispondere alle esigenze di ogni ambiente. Dotata di un ampio cassetto con chiave, vani a vista e un'anta con ripiano interno, offre anche un divisorio in marrone tiger per un'area privata, che può essere posizionato sia a destra che a sinistra per una gestione personalizzata dello spazio. Ogni elemento è pensato per accogliere in modo elegante e organizzato, creando un ambiente che comunica professionalità fin dal primo sguardo.

Elegance and functionality for every reception.

NAT 16/9 Reception is the ideal synthesis of refined design and functionality. Made of melamine faced board, available in different finishes, this reception desk is designed to meet the needs of every location. Equipped with a large drawer with key, open compartments and a door with internal shelf, it also offers a tiger brown divider for a private area, which can be positioned either on the right or left for personalized space management. Each element is designed to welcome in an elegant and organized way, creating a location that communicates professionalism from the first look.



Reception NAT 16/9 realizzata in nobilitato, disponibile in 7 diverse finiture, dotata di cassetto con chiave, vani a vista, anta con ripiano interno e divisorio in marrone tiger per area privata, posizionabile a destra o a sinistra.

Reception NAT made of melamine faced-board available in 7 different finishes, equipped with one drawer with key, free compartments, door with inner shelf and front partition in tiger brown for private area, that can be positioned on the right or on the left.

FINITURA | FINISH

Divisorio marrone tiger
Tiger brown front partition

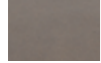

Finitura nobilitato
Melamine faced finish



VIP 22 VIP 23 VIP 24 VIP 25

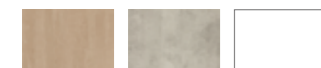

VIP 52 VIP 49 VIP 00

DIMENSIONI (mm) | DIMENSIONS (mm)

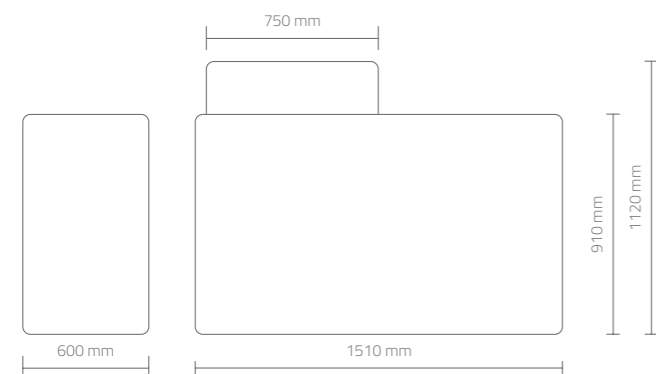

VERSION LEFT
VERSION RIGHT

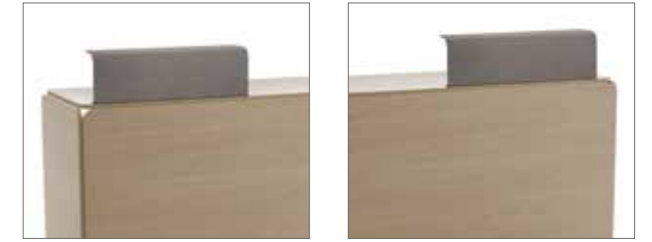



LIGHT

La perfetta combinazione di eleganza e funzionalità.

La Reception Light si distingue per il suo design minimal e raffinato, realizzata in nobilitato bianco opaco. Il pannello frontale retro-illuminato aggiunge un tocco di classe, garantendo allo stesso tempo riservatezza e semplicità. Le Vetrinette Light, con teca in vetro illuminata a Led, danno la possibilità di ampliare lo spazio espositivo, conferendo un'eleganza moderna e un'atmosfera luminosa.

The perfect combination of elegance and functionality.

Reception Light stands out for its minimal and refined design, made of matt white melamine faced board. The backlit front panel adds a touch of class, while ensuring privacy and simplicity. Light display case, with a glass case illuminated by LEDs, give the possibility of expanding the exhibition space, giving a modern elegance and a bright atmosphere.







VETRINETTA LIGHT



RECEPTION LIGHT



FINITURA | FINISH

Struttura bianco opaco
Matt white structure



Finitura nobilitato
Melamine faced finish

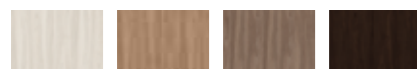

VIP 22 VIP 23 VIP 24 VIP 25

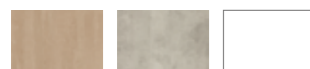

VIP 52 VIP 49 VIP 00

RECEPTION LIGHT

Light è una reception minimale che si caratterizza per la sua eleganza. È realizzata in nobilitato bianco opaco. La reception può essere composta dal solo modulo centrale (Reception Light) oppure si possono aggiungere una o due vetrine espositive Light (destra e/o sinistra). Il modulo fisso centrale è riservato e funzionale: è dotato di piano estraibile porta-planning, foro passacavi, cassetto con chiusura, vano a giorno e anta con ripiano. Il pannello frontale retro-illuminato disponibile in 7 finiture oltre a garantire riservatezza permette di avere un piano d'appoggio e semplicità.

Light is a minimalist reception desk characterized by its elegance. It is made of matt white melamine-faced board. This reception can be composed by central desk only (Light Reception desk) or one or two Light display windows can be added (right and/or left). The central module is reserved and functional: it is equipped with extractable door-planning, cable hole, drawer with closing, day compartment and door with shelf. The backlit front panel available in 7 finishes guarantees privacy and offers a supporting surface.

VETRINETTA LIGHT

Semplicità nel disegno e nella forma ed una linea geometrica minimale conferiscono alla vetrina espositiva Light un'immagine moderna ed elegante. È realizzata in legno nobilitato bianco opaco con teca in vetro illuminato a Led.

Simplicity in design and shape and a minimal geometric line give to the Light display case a modern and refined image. It is made of matt white melamine-faced board with glass showcase with Led lighting.

DIMENSIONI (mm) | DIMENSIONS (mm)

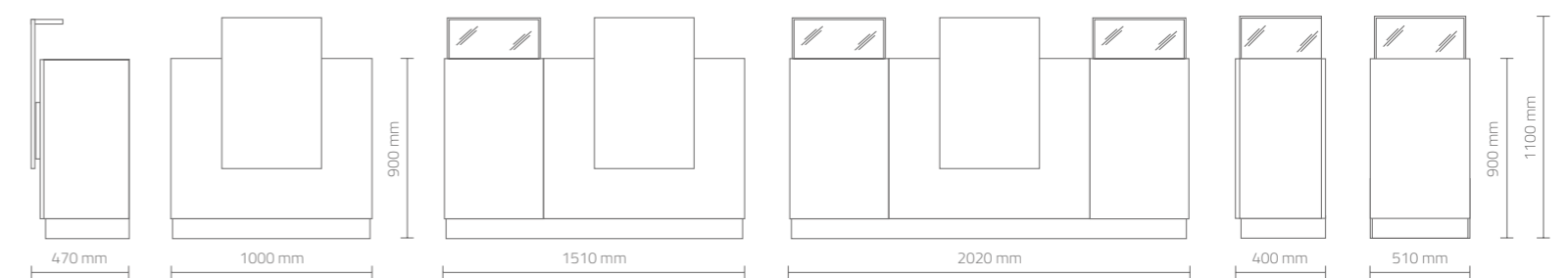

COMPLEMENTI E ACCESSORI *COMPLEMENTS AND ACCESSORIES*

CARRELLO NAT CREO	194
CARRELLO OBORO LIVING	195
CARRELLO MADE SWING	196
CARRELLO ARCUS	197
SPECCHIO MAKE-UP	197
CASSETTIERA LIVING NAIL NAT	198
MENSOLA NAT SLIM	200
MENSOLA STRATOS	201
MENSOLA ARCUS	201
SEDIA BRIO	202
SGABELLO EASY	202
SGABELLO FLEX	203
ASPIRATORE FILTRO HELIOS 280	204
PIASTRA RISCALDANTE HOT	205

CARRELLO NAT
TROLLEY NAT

FINITURA | FINISH

Finitura nobilitato
Melamine faced finish

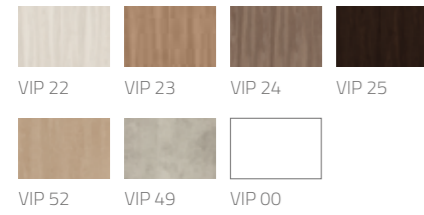

DIMENSIONI (mm) | DIMENSIONS (mm)

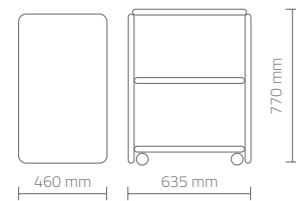

Carrello realizzato in nobilitato, disponibile in 7 diverse finiture, dotato di tre ripiani e passacavo.

Trolley made of melamine faced-board available in 7 different finishes, equipped with 3 shelves and hole for cable.



CARRELLO OBORO
TROLLEY OBORO

FINITURA | FINISH

Struttura laccato bianco opaco
Matt white lacquered structure



DIMENSIONI (mm) | DIMENSIONS (mm)

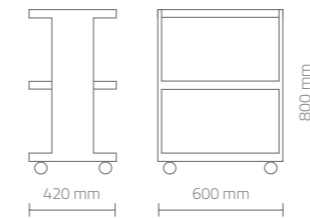

Oboro è un carrello realizzato in legno multistrato di betulla a tre ripiani disponibile in finitura laccato bianco. La sua versatilità lo rende un carrello unico. Il vassoio superiore durante la fase di montaggio può essere girato e posizionato a filo struttura, soluzione ideale come piano d'appoggio per i macchinari.

Oboro is a trolley made of multilayer birch wood. It is equipped with three shelves and it is available in finishes white lacquered. Its versatility makes it a unique trolley. During the assembling, upper shelf can be reversed and positioned flush with structure. This is a perfect solution for machineries' placing.

CARRELLO CREO
TROLLEY CREO

FINITURA | FINISH

Struttura bianco opaco
Matt white structure



Finitura nobilitato
Melamine faced finish

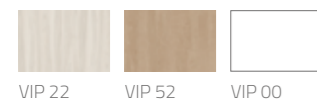

DIMENSIONI (mm) | DIMENSIONS (mm)

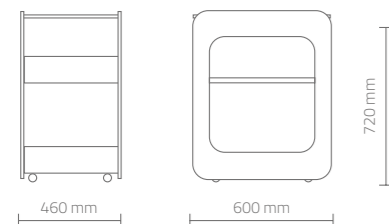

Creo è un ottimo complemento di lavoro dal carattere originale e raffinato, realizzato in nobilitato bianco opaco con ripiani disponibili in 3 diverse finiture. Pensato nei minimi dettagli, Creo è adattabile ad ogni esigenza. Il piano superiore durante la fase di montaggio può essere posizionato a filo struttura, soluzione ideale come piano d'appoggio per i macchinari.

Creo is an excellent complement, original and refined, made of matt white melamine-faced board with shelves available in 3 different finishes. Creo can be used for different uses; during assembling top shelf can be positioned flush structure, the best solution as support tray for machineries.



CARRELLO LIVING
TROLLEY LIVING

FINITURA | FINISH

Struttura bianco opaco
Matt white structure



Finitura nobilitato
Melamine faced finish

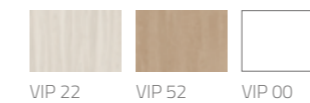

DIMENSIONI (mm) | DIMENSIONS (mm)

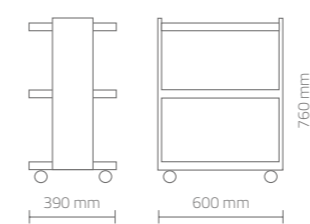

Carrello realizzato in nobilitato bianco opaco con ripiani disponibili in 3 diverse finiture. Living è un carrello lineare e semplice, curato nei particolari che si adatta facilmente ad ogni tipo di ambiente. Il piano superiore durante la fase di montaggio può essere posizionato a filo struttura, soluzione ideale come piano d'appoggio per i macchinari.

Trolley made of matt white melamine-faced board with shelves available in 3 different finishes. Living is a linear and simple trolley for any location. During assembling top shelf can be positioned flush structure, the best solution as support tray for machineries.

CARRELLO MADE
TROLLEY MADE

FINITURA | FINISH

Struttura bianco opaco
Matt white structure



DIMENSIONI (mm) | DIMENSIONS (mm)

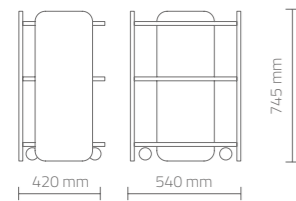

Made è un carrello realizzato in legno multistrato di betulla a tre ripiani disponibile in finitura bianco opaco. La sua versatilità lo rende un carrello unico.

Made is a trolley made of multilayer birch wood. It is equipped with three shelves and it is available in matt white finish. Its versatility makes it a unique trolley.

CARRELLO ARCUS
TROLLEY ARCUS

FINITURA | FINISH

Struttura argento/dorato
Silver/gold structure



DIMENSIONI (mm) | DIMENSIONS (mm)

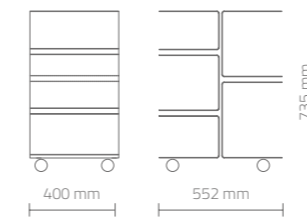

Carrello realizzato in acciaio verniciato argento/dorato, tre ripiani sono impreziositi da cornici che oltre ad impreziosire il carrello hanno una funzione contenitiva.

Trolley made of silver/gold painted steel, featuring three shelves adorned with frames that not only enhance its elegance but also have a containment function.

CARRELLO SWING
TROLLEY SWING

FINITURA | FINISH

Struttura bianco opaco
Matt white structure



Finitura nobilitato
Melamine faced finish

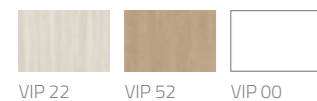

DIMENSIONI (mm) | DIMENSIONS (mm)

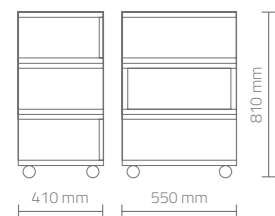

Carrello realizzato in nobilitato bianco opaco, dotato di due cassetti push & pull e un vano a giorno centrale. Frontali cassetti in legno disponibili in 3 diverse finiture: rovere bardolino, larice bianco, wengé naturale.

Trolley made of matt white melamine-faced board provided with 2 push & pull drawers and one central compartment. Front details available in 3 different finishes: bardolino oak, white larch, natural wengé.

SPECCHIO MAKE-UP
MAKE-UP MIRROR

FINITURA | FINISH

Struttura bianco opaco
Matt white structure



DIMENSIONI (mm) | DIMENSIONS (mm)

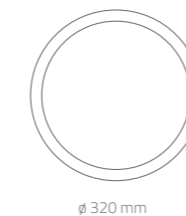

Specchio con telaio in alluminio verniciato bianco, con illuminazione led ad alta potenza. La luce naturale è diffusa nel perimetro dello specchio.

Wall mirror with aluminium frame painted white, and high potency led lighting. The natural light, spread out through its perimeter, is concealed behind the mirror.

CASSETTIERA LIVING
CHEST OF DRAWERS LIVING

FINITURA | FINISH

Struttura bianco opaco
Matt white structure



Finitura nobilitato
Melamine faced finish



VIP 22 VIP 52 VIP 00

DIMENSIONI (mm) | DIMENSIONS (mm)

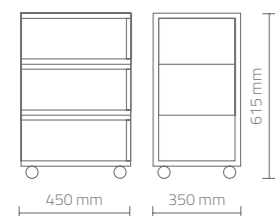

Cassettiera Living realizzata in nobilitato bianco opaco con cassetti disponibili in 3 diverse finiture. È utilizzata come complemento dei tavoli Living e Living Led.

Chest of drawers made of matt white melamine faced-board with drawers available in 3 different finishes. It is used as a complement with Living and Living Led tables.

CASSETTIERA NAIL NAT
CHEST OF DRAWERS NAIL NAT

FINITURA | FINISH

Struttura bianco opaco
Matt white structure



DIMENSIONI (mm) | DIMENSIONS (mm)

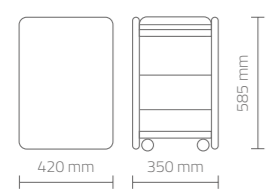

Cassettiera Nail Nat in nobilitato bianco opaco, dotata di cassetto, vano porta flaconi e piano superiore porta-smalti.

Chest of drawers Nail Nat made of matt white melamine-faced board, equipped with drawer, bottle holder compartment and top shelf for nail polishes.



MENSOLE NAT
SHELVES NAT



FINITURA | FINISH

Struttura bianco opaco
Matt white structure



Finitura nobilitato
Melamine faced finish

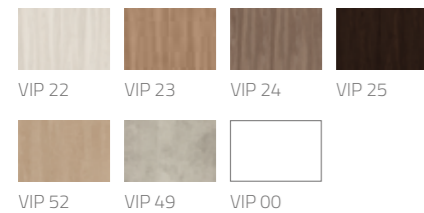

DIMENSIONI (mm) | DIMENSIONS (mm)



Mensola a parete in nobilitato bianco opaco con bordatura disponibile in 7 finiture.

Wall shelves in matt white melamine-faced board and border available in 7 finishes.

MENSOLE SLIM
SHELVES SLIM

FINITURA | FINISH

Struttura bianco opaco
Matt white structure



Finitura nobilitato
Melamine faced finish

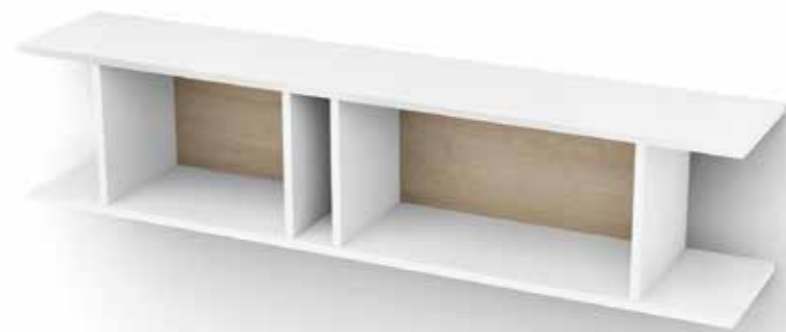
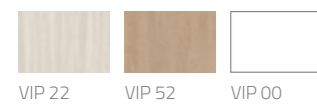

DIMENSIONI (mm) | DIMENSIONS (mm)



Mensola da parete posizionabile in verticale o orizzontale con struttura bianco opaco e pannello a parete personalizzabile in 3 diverse finiture. La mensola Slim permette di creare innumerevoli composizioni in base al gusto e all'esigenza del cliente. Affiancando più moduli si possono arredare pareti creando un gioco di movimenti.

At-wall shelf with horizontal or vertical positioning white matt frame and wall panel available in 3 different finishes. Slim shelf allows to create countless set-up based on customer style and need. The client can decorate the wall by placing side by side various modules and create movements game.

MENSOLE STRATOS
SHELVES STRATOS

FINITURA | FINISH

Struttura bianco opaco
Matt white structure



Finitura nobilitato
Melamine faced finish

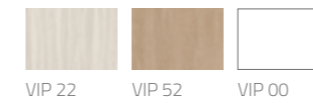

DIMENSIONI (mm) | DIMENSIONS (mm)



Stratos è una mensola da parete lineare, semplice ed essenziale, personalizzabile in 3 diverse finiture.

Stratos is a linear at-wall shelf, simple and essential, available in 3 different finishes.

MENSOLE ARCUS
SHELVES ARCUS

FINITURA | FINISH

Struttura argento/dorato
Silver/gold structure



DIMENSIONI (mm) | DIMENSIONS (mm)



Mensola realizzata in acciaio verniciato argento/dorato, la forma semplice ed elegante permette l'affiancamento di più mensole.

Shelf made of silver/gold painted steel, with a simple and elegant design that allows multiple shelves to be placed side by side.

SEDIA BRIO
CHAIR BRIO

FINITURA | FINISH

Base in acciaio
Steel base



Seduta bianco
White seat



DIMENSIONI (mm) | DIMENSIONS (mm)

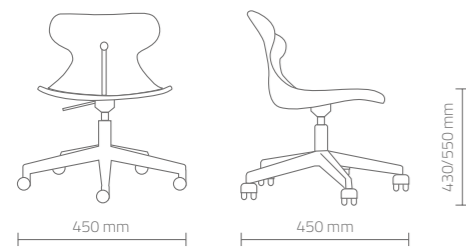

Sedia con seduta bianca e basamento con ruote in acciaio cromato. L'altezza della sedia è regolabile attraverso un sistema di regolazione a gas.

Chair with white seat and chrome-plated steel basement with wheels. Seat height can be adjusted through a gas regulation system.

SGABELLO EASY
STOOL EASY

FINITURA | FINISH

Base in acciaio
Steel base



Seduta bianco
White seat



DIMENSIONI (mm) | DIMENSIONS (mm)

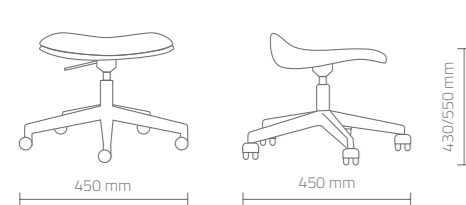

Sgabello con seduta bianca in poliuretano espanso e basamento in acciaio cromato con ruote. L'altezza, con regolazione a gas, è variabile.

Stool with polyurethane white seat and chrome-plated steel base with wheels. Adjustable height with gas lift.

SGABELLO FLEX
STOOL FLEX

Flex è uno sgabello oscillante con sedile schiumato rivestito in skai. È dotato di doppio pulsante per la regolazione in altezza (escursione 230mm). La base è in gomma anti-stridio.

Flex is an oscillating stool with skai-covered foam seat. It is equipped with a double button for height adjustment (230mm travel). The base is in anti-screech rubber.



FINITURA | FINISH

Struttura bianco opaco
Matt white structure



Finitura colori skai
Skai colours finish



DIMENSIONI (mm) | DIMENSIONS (mm)

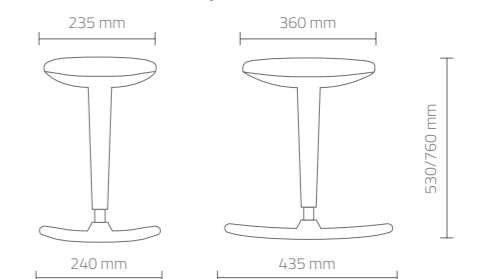

ASPIRATORE HELIOS 280
NAIL ASPIRATOR HELIOS 280



VIDEO



DIMENSIONI (mm) | DIMENSIONS (mm)

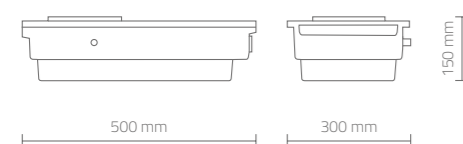

Aspiratore fisso per polveri di limatura per unghie per tavoli manicure Living, Living Led e Nail Nat. Helios 280 è estremamente silenzioso (65 dB) e caratterizzato da comandi intuitivi. La massima aspirazione è di 280 M3/h. È dotato di filtro estraibile per permettere una pulizia facile e completa.

Fixed aspirator for nail filing powder for Living, Living Led and Nail Nat manicure tables. Helios 280 is extremely silent (65 dB) and characterized by intuitive controls. The maximum suction is 280 M3/h. It is equipped with removable filter for a easy and complete cleaning.

FILTRO ASPIRATORE HELIOS 280
NAIL ASPIRATOR FILTER HELIOS 280



Filtro estraibile per aspiratore Helios 280 per una pulizia completa. Dotato di microgranuli di carbone attivo in grado di abbattere gli odori.

Removable filter for Helios 280 aspirator for a complete cleaning with microgranules of activated carbons to eliminate smell.

PIASTRA HOT
HEATING PLATE HOT

FINITURA | FINISH

Struttura bianco opaco
Matt white structure



Piano in acciaio
Steel top



DIMENSIONI (mm) | DIMENSIONS (mm)



Piastra riscaldante professionale con piano in acciaio e tasto retroilluminato RGB per la regolazione delle quattro temperature (step 45°/50°/55°/60°).

Professional hot plate with steel top. RGB backlit button for temperature adjustment (step 45°/50°/55°/60°).



FINITURE

FINISHES

BENVENUTI NEL MONDO DELLE FINITURE VISMARA: LEGNO E SKAI, TRA ELEGANZA E PERSONALIZZAZIONE.

La scelta delle finiture è un elemento fondamentale per definire l'identità di un arredo e creare atmosfere uniche. Vismara offre una selezione esclusiva di finiture in legno e skai, pensate per soddisfare ogni esigenza estetica e funzionale, sia in ambienti classici che moderni.

Finiture in legno

Raffinatezza naturale, robustezza e versatilità. Disponibili in un'ampia gamma di tonalità, dalle essenze più calde come il noce o il rovere, fino a finiture più moderne come il bianco opaco o il paper. Ogni legno è trattato con tecniche all'avanguardia per esaltarne la texture naturale, garantendo durabilità e un'estetica impeccabile.

Finiture in skai

Un rivestimento di alta qualità che unisce eleganza e praticità. Grazie a una vasta gamma di colori, dalle tonalità neutre e delicate fino ai colori più vivaci e audaci, lo skai offre infinite possibilità di personalizzazione. Facile da pulire e resistente all'usura, rappresenta la scelta ideale per chi cerca un design moderno senza compromessi sulla resistenza.

Con Vismara, ogni finitura è pensata per valorizzare al meglio i vostri ambienti, trasformando ogni arredo in un'opera unica e personalizzata. Lasciatevi ispirare dalle nostre proposte e scegliete il colore e la texture che meglio rispecchiano il vostro stile.

WELCOME TO THE WORLD OF VISMARA FINISHES: WOOD AND SKAI, WHERE ELEGANCE MEETS CUSTOMIZATION.

The choice of finishes is a fundamental element in defining the identity of furniture and creating unique atmospheres. Vismara offers an exclusive selection of wood and skai finishes, designed to meet every aesthetic and functional need, whether in classic or modern environments.

Wood finishes

Natural refinement, strength, and versatility. Available in a wide range of tones, from warmer woods like walnut and oak to more contemporary finishes like matte white or paper. Each wood is treated with advanced techniques to enhance its natural texture, ensuring durability and impeccable aesthetics.

Skai finishes

A high-quality finish that combines elegance and practicality. With a vast selection of colors, ranging from neutral and delicate tones to vibrant and bold shades, skai offers endless customization possibilities. Easy to clean and resistant to wear, it is the ideal choice for those seeking modern design without compromising on durability.

With Vismara, every finish is designed to enhance your spaces, turning each piece of furniture into a unique and personalized creation. Let our proposals inspire you and choose the color and texture that best reflect your style.

Struttura e finitura piano nobilitato

Structure and finish of the melamine faced board



VIP 22
Noce bianco
White walnut



VIP 23
Noce light
Light walnut



VIP 24
Noce canaletto
Canaletto walnut

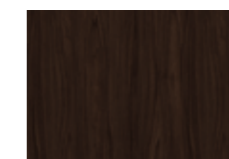

VIP 25
Noce scuro
Dark walnut



VIP 52
Rovere naturale
Natural oak

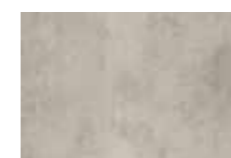

VIP 49
Corda
Tan



VIP 04
Paper
Paper



VIP 00
Bianco opaco
Matt white

Colori skai

Skai colours



VIS 10
Bianco
White

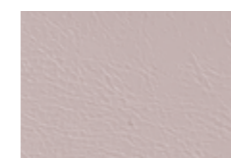

VIS 11
Rosa antico
Antique pink



VIS 18
Petrolio
Dark teal

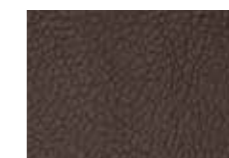

VIS 30
Testa di moro
Dark brown



VIS 32
Marrone chiaro
Light brown



VIS 34
Beige
Beige



VIS 40
Nero
Black



VIS 42
Grigio scuro
Dark grey



VIS 44
Grigio chiaro
Light grey

Colori skai premium

Premium skai colours



VIS 51N
Tortora
Dove-grey



VIS 53N
Sabbia
Sand



VIS 63N
Jeans
Jeans



VIS 70N
Cenere
Ash

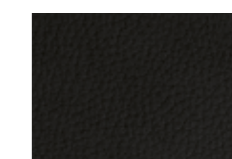

VIS 71N
Nero
Black

Vismara s.r.l. si riserva il diritto
di modificare o sostituire i propri modelli,
componenti o listini prezzi, senza nessun preavviso.
Le misure possono variare di ± 2 cm.

*Vismara s.r.l. reserves the right
to change or substitute the models,
components or price lists without prior notice of any kind.
Measures can vary by ± 2 cm.*

CONCEPT Creative Company Srl
ART DIRECTOR Marco Maria Lantero
IMPAGINAZIONE Valeria Mariani
Katuscia Ballabio
PHOTO Luca Proserpio
PRINTING Ingraph Srl

STAMPATO IN ITALIA | marzo 2025

Vismara s.r.l.

via Salvo D'Acquisto, 19
20833 Paina Di Giussano (MB)
Tel. +39 0362 236169

info@vismarabenessere.it
export@vismarabenessere.it
www.vismarabenessere.it

